

DEEPREY®

MULTI FUNCTION DISPLAY

Model **DP185/215XL**

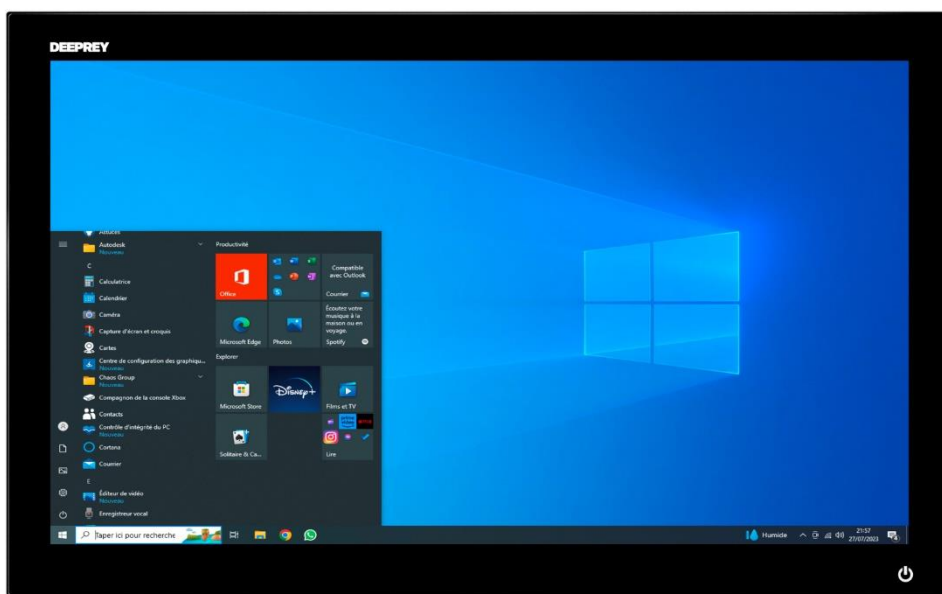

(Product Name: MULTI FUNCTION DISPLAY)

DEEPREY MARINE EQUIPEMENTS

www.deeprey.com

OPERATOR'S MANUAL

Copyright © 2023 DEEPREY Inc. All rights reserved. Trademarks used in this document: FURUNO®, LOWRANCE®, GARMIN®, the Ublox® logo, U-center®, Timezero®, and Wi-Fi Catcher™ are trademarks. Intel® and Core™ are either registered trademarks or trademarks of Intel Corporation in the United States and/or other countries. Microsoft®, Windows®, MS-DOS®, the Windows Start button are either trademarks or registered trademarks of Microsoft Corporation in the United States and/or other countries. Wi-Fi® is a registered trademark of Wireless Ethernet Compatibility Alliance, Inc.

2023-03

Rev. 1.02

IMPORTANT NOTICES

1. Legal and Compliance Statements

1.1. Regulatory Compliance:

This product has been tested and found to comply with the requirements set forth by regulatory authorities for the regions in which it is sold. These requirements may include, but are not limited to, compliance with the following:

- Federal Communications Commission (FCC) Rules, United States
- Conformité Européenne (CE) Marking, European Union
- Industry Canada (IC) Standards, Canada
- Other applicable regional or national regulations and standards



1.2. Safety Precautions and Guidelines:

Refer to the Safety Precautions and Warnings section of this manual for detailed information on safe use, handling, and maintenance of this product. Failure to adhere to these guidelines may result in personal injury or damage to the product and void the warranty.

2. Disclaimers

Deepry does not warrant that this product is error-free or that it is compatible with products manufactured by any person or entity other than Deepry.

Deepry is not responsible for damages or injuries caused by your use or inability to use the product, by the interaction of the product with products manufactured by others, or by errors in information utilized by the product supplied by third parties.

Unauthorized Software and Modifications:

The user is strictly prohibited from installing, copying, or using pirated or unauthorized software, applications, or modifications on the Deepry MFD. The manufacturer will not be held responsible for any damages, issues, or legal consequences resulting from the use of pirated or unauthorized software.

Violation of this policy may void the warranty, result in termination of support services, and expose the user to legal liabilities. Users are responsible for ensuring that all software installed on the Deepry MFD is obtained from legitimate sources and complies with applicable licensing terms and conditions.

By using this product, you acknowledge and agree to comply with all applicable laws, regulations, and terms related to software licensing and intellectual property rights protection. Failure to do so may result in legal consequences, damages, or voiding of the product warranty.





3. Copyright Notice





All rights reserved. No part of this user manual may be reproduced, distributed, transmitted, or translated in any form or by any means, electronic or mechanical, including photocopying, recording, or any information storage and retrieval system, without the prior written permission of the manufacturer. All product names, logos, and brands mentioned in this manual are the property of their respective owners.

SAFETY INSTRUCTIONS





Be sure to observe the safety instructions

Be sure to observe the following instructions to prevent danger to yourself and others and damage to your property. The levels of danger and damage that may result when displayed contents are ignored or the equipment is used incorrectly are classified and indicated in this manual as shown below. Pay sufficient attention to those dangers and damage.

 WARNING	Indicates a condition that can cause death or serious injury if used incorrectly.
 CAUTION	Indicates a condition that can cause minor or moderate injury or damage to property if used incorrectly.
 Warning, Caution	 Prohibitive Action
	 Mandatory Action

 WARNING	
	Use the proper fuse. Use of a wrong fuse can result in serious accident or malfunction.
	Never disassemble or modify the equipment. Fire, electrical shock or injury can result.
	Immediately turn off the power at the switchboard if water leaks into the equipment. Fire or electrical shock can result.

 CAUTION
<p>About plotting accuracy</p> <p>The plotting accuracy and response speed of this TT meet the International Maritime Organization (IMO) standards. Tracking accuracy is affected by the following.</p> <p>Tracking accuracy is not affected by slow course change of own ship. However, abrupt course change affects all tracking targets and one to two minutes is required to restore full accuracy for those targets. (The degree of impact depends on gyrocompass.)</p>

 WARNING	
	Do not place liquid-filled containers on the equipment. Fire or electrical shock can occur if liquid spills into the equipment.
	Never remove cover. High voltage is used inside. Electrical shock may result if you touch high voltage components. In case of malfunction, contact your dealer.
	Immediately turn off the power at the switchboard if the equipment is emitting smoke or fire. Fire or electrical shock can result. Be sure to contact your dealer.
	Do not operate the equipment with wet hands. Electrical shock can result.

DEEPREY®

OPERATOR'S MANUAL MULTI FUNCTION DISPLAY Models **DP185XL-DP215XL**

IMPORTANT NOTICES	III
SAFETY INSTRUCTIONS	IV
1 SYSTEM CONFIGURATION	1-4
1.1 CONFIGURATION WITH CHARTPLOTTER	1-4
1.1.1 Any chartplotter	1-4
1.1.2 Chartplotter compatible with Timezero	1-5
1.2 CONFIGURATION WITH BLACKBOX	1-6
1.2.1 One display unit	1-6
1.2.2 Multiple display units	1-6
1.3 ADVANCED CONFIGURATION	1-7
2 EQUIPEMENT LIST	2-8
2.1 STANDARD SUPPLY	2-8
2.2 OPTIONAL SUPPLY	2-8
3 INSTALLATION	3-8
3.1 MOUNTING	3-8
3.1.1 Place suitable for mounting	3-8
3.1.2 Bracket mount	<i>Error! Bookmark not defined.</i>
3.1.3 Flush mount	3-9
3.2 WIRING	3-11
3.2.1 Main body (rear) interface	3-11
3.2.2 Multi cable	3-12
3.2.3 Power connection	3-12
3.3 NMEA2000 CONNECTOR	3-13
3.3.1 NMEA2000 network connection	3-14
3.3.2 NMEA2000 pin definition	3-14
3.4 NMEA2000 PGN	3-15
3.4.1 Input PGN	3-15
3.4.2 Output PGN	3-16
4 BASIC OPERATION	4-19
4.1 CONTROLS	4-19
4.1.1 Power button	4-19
4.1.2 Touch control	4-21

4.2 ADJUST BRIGHTNESS.....4-22

5 EMBEDDED GPS ERROR! BOOKMARK NOT DEFINED.

5.1 TECHNICAL SPECIFICATIONS:..... **ERROR! BOOKMARK NOT DEFINED.**

5.2 NMEA0183 SENTENCES **ERROR! BOOKMARK NOT DEFINED.**

5.3 DEFAULT CONFIGURATION **ERROR! BOOKMARK NOT DEFINED.**

5.4 ADVANCED CONFIGURATION **ERROR! BOOKMARK NOT DEFINED.**

6 TECHNICAL SPECIFICATIONS 5-23

7 BIOS SETUP 6-25

7.1 ENTERING THE BIOS.....6-25

7.2 MAIN SETUP6-25

7.3 ADVANCED SETTINGS6-26

7.3.1 *Power and performance*6-27

7.3.2 *CPU-Power Management Control*.....6-27

7.3.3 *GT-Power Management Control*6-29

7.3.4 *Thermal Configuration*.....6-29

7.3.5 *ACPI Settings*6-30

7.3.6 *IT8786 Super IO Configuration*.....6-31

7.3.7 *Hardware Monitor*6-32

7.3.8 *Smart Fan Function*6-33

7.3.9 *Watch Dog Configuration*6-33

7.3.10 *S5 RTC Wake Settings*.....6-34

7.3.11 *USB Configuration*6-34

7.3.12 *Network Stack Configuration*6-35

7.3.13 *NVME Configuration*.....6-36

7.4 CHIPSET6-36

7.4.1 *State After G3*.....6-37

7.5 SECURITY.....6-37

7.6 BOOT.....6-38

7.7 SAVE AND EXIT.....6-39

7.8 STEPS FOR EHL35V20 LVDS ADJUSTMENT UNDER THE BIOS.....6-40

8 OUTLINE DRAWINGS 7-42

1 SYSTEM CONFIGURATION

1.1 Configuration with chartplotter

1.1.1 Any chartplotter

1. NMEA2000 Connection

The DP-MFD offers versatile connectivity to any sounder. Whether it's from an older or newer generation, using protocols like NMEA2000, NMEA0183, WIFI or Ethernet. By combining this hardware with software like Timezero, you'll be able to create your own detailed bathymetric maps of your fishing spots.

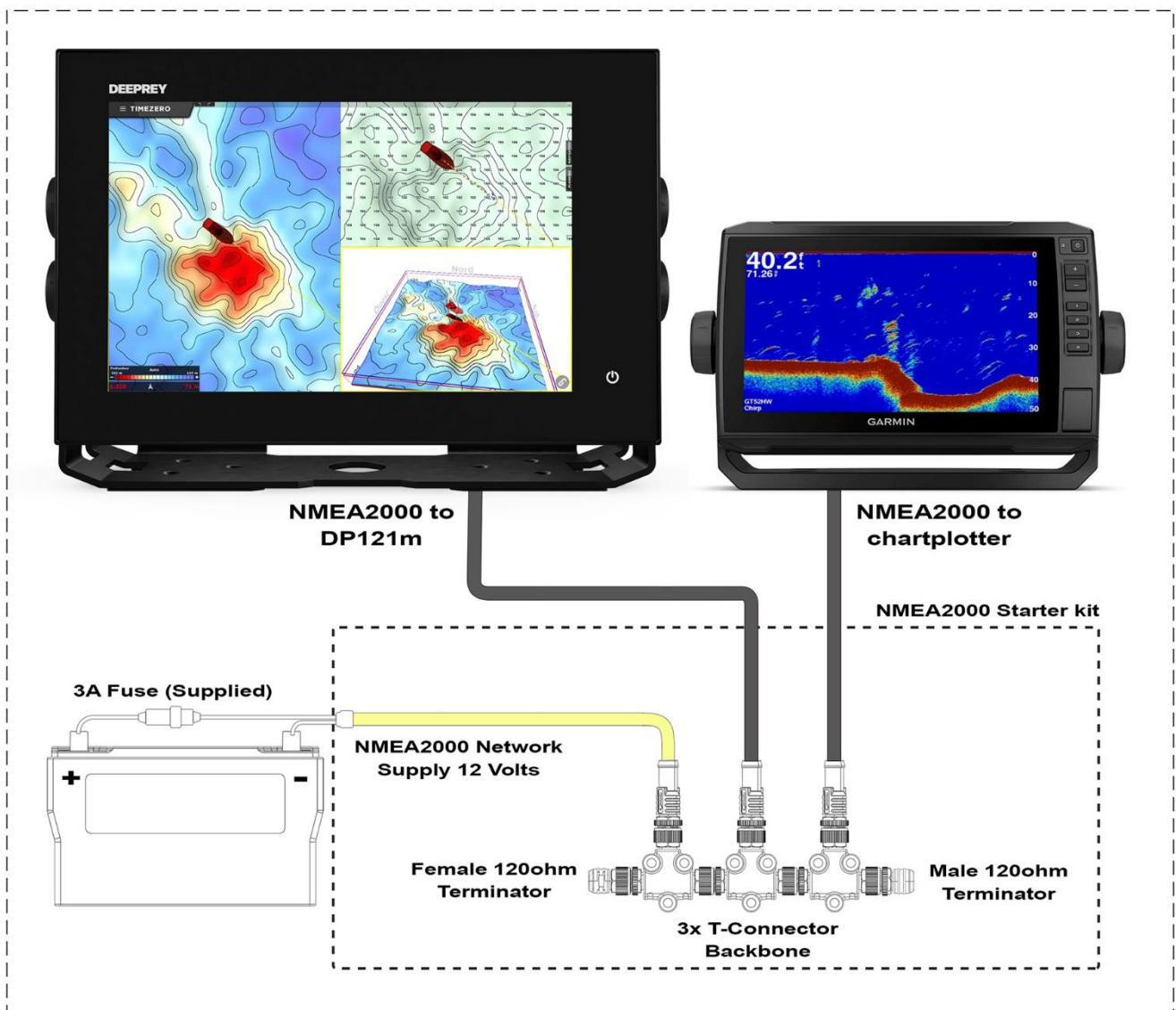

2. WIFI Connection

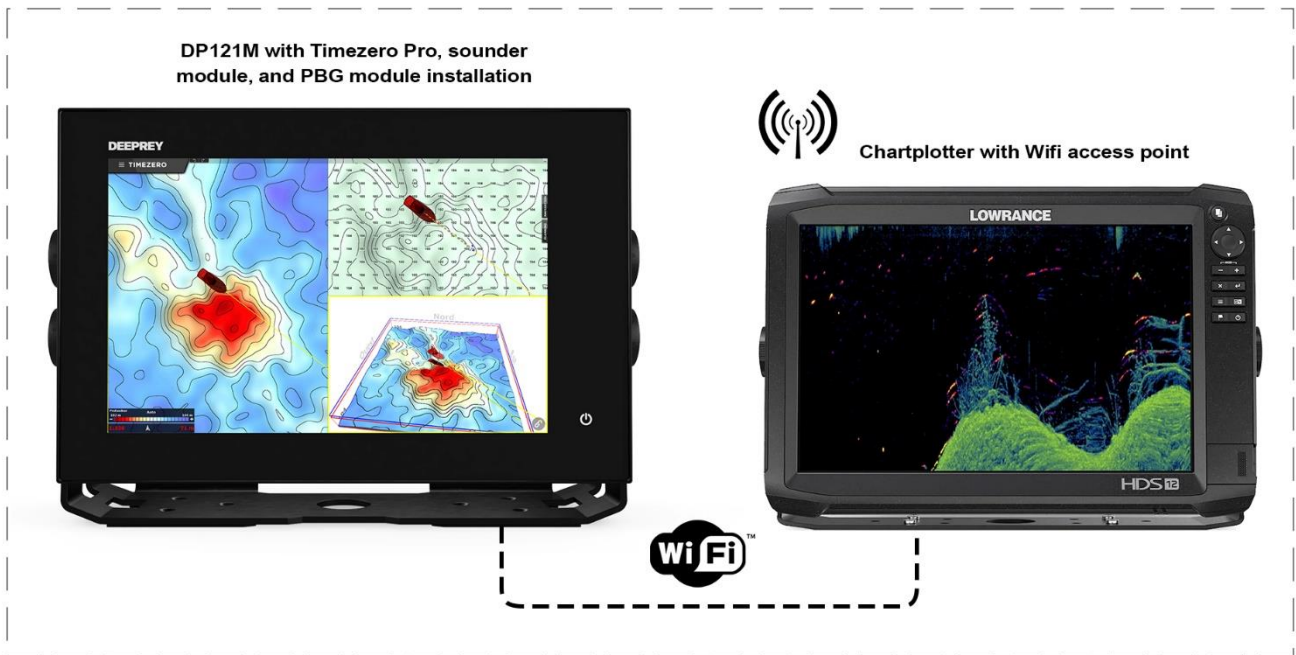

1.1.2 Chartplotter compatible with Timezero

With a chartplotter compatible with Timezero, such as the Tztouch2, Tztouch3, or the FCV-1150, and a simple Ethernet connection, you can have complete access to your sounder. This will allow you to access the sonar view on the DP-MFD and make your bathymetric recordings in real-time for a better understanding of your fishing spots.

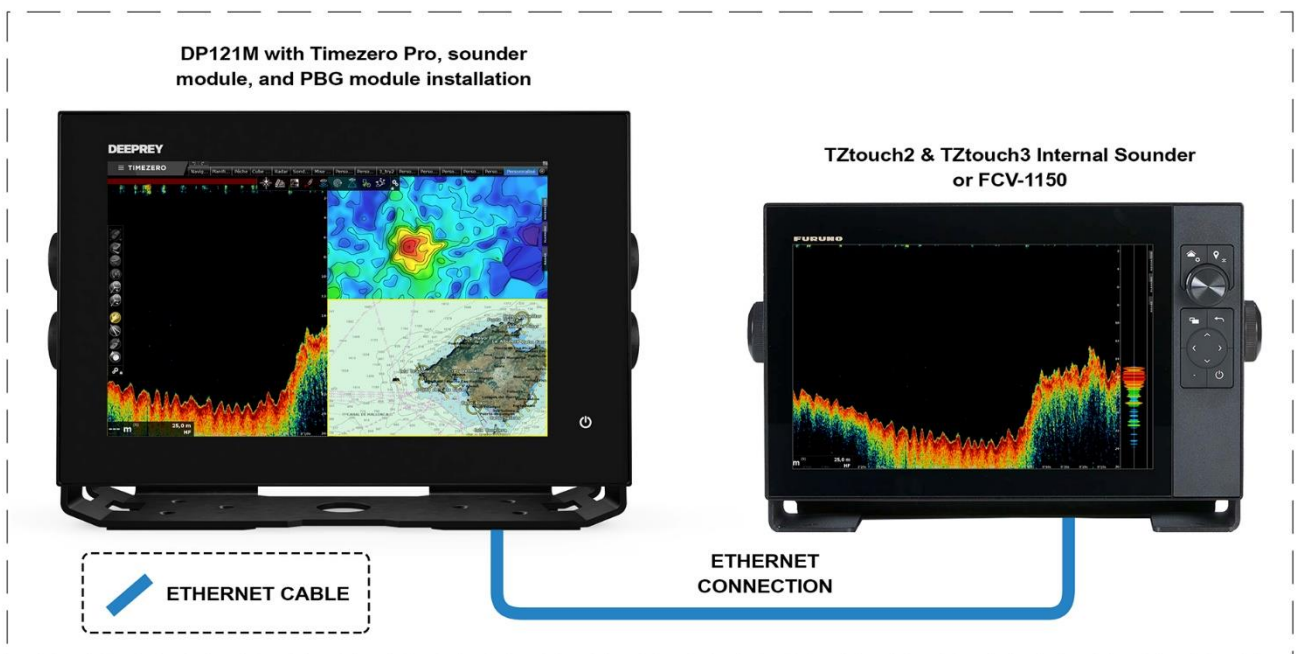

1.2 Configuration with blackbox

1.2.1 One display unit

With a Timezero-compatible black box sounder, such as DFF1, DFF3, BBDS1, or DFF1-UHD, and a simple Ethernet connection, you gain full access to your black box. This allows you to configure it and access various sonar views provided by the black box. Additionally, you can conduct real-time bathymetric surveys of your fishing spots and more effectively identify new spots.

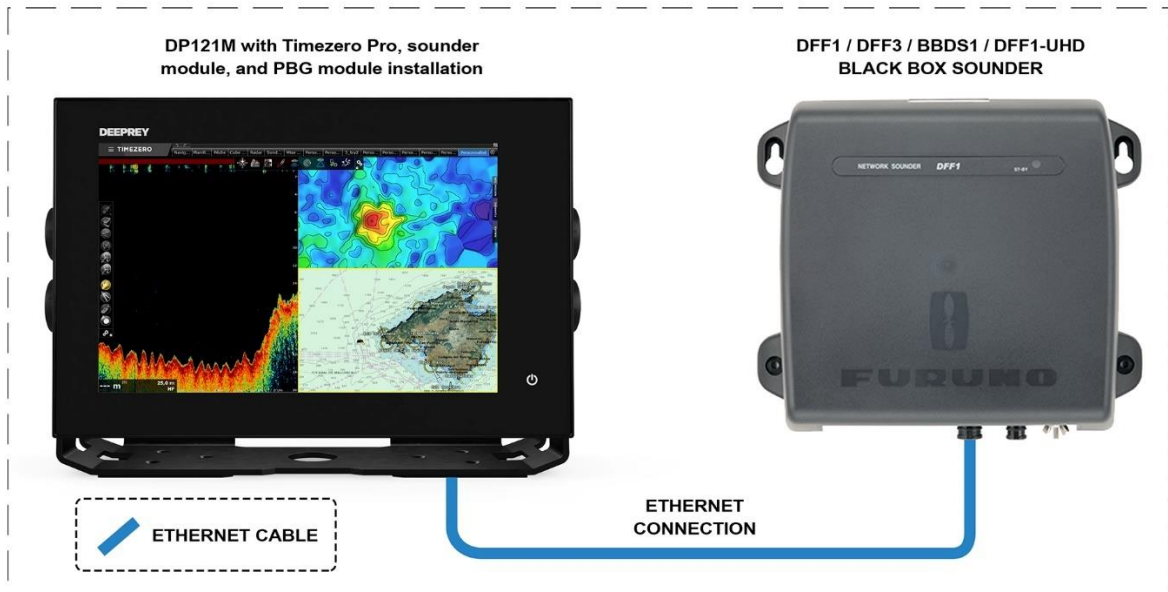

1.2.2 Multiple display units

You can connect multiple DP-MFD units to a blackbox or a Timezero-compatible chartplotter using an Ethernet switch, allowing you to display sonar data and other equipment on multiple screens. Additionally, you'll be able to manage this information simultaneously from all screens.

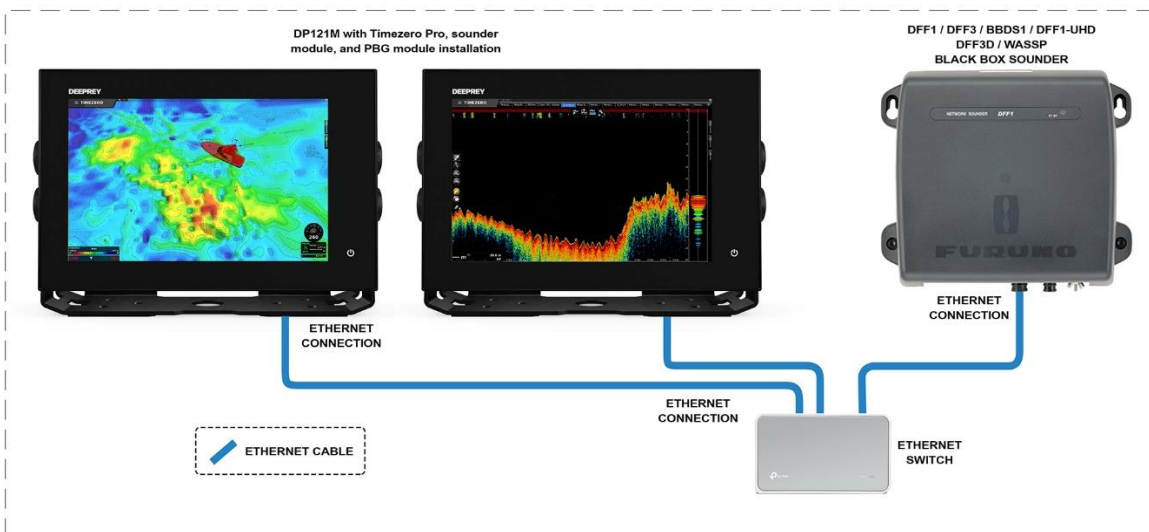

1.3 Advanced configuration

The installation of Timezero and the sounder, radar, and PBG modules enables you to connect Furuno radars and Timezero-compatible sonars via Ethernet. Additionally, you can establish connections with an autopilot computer and an external GPS through Nmea2000. The DP-MFD will allow you to control all equipment, synchronize all received data, and display a professional and accurate navigation interface.

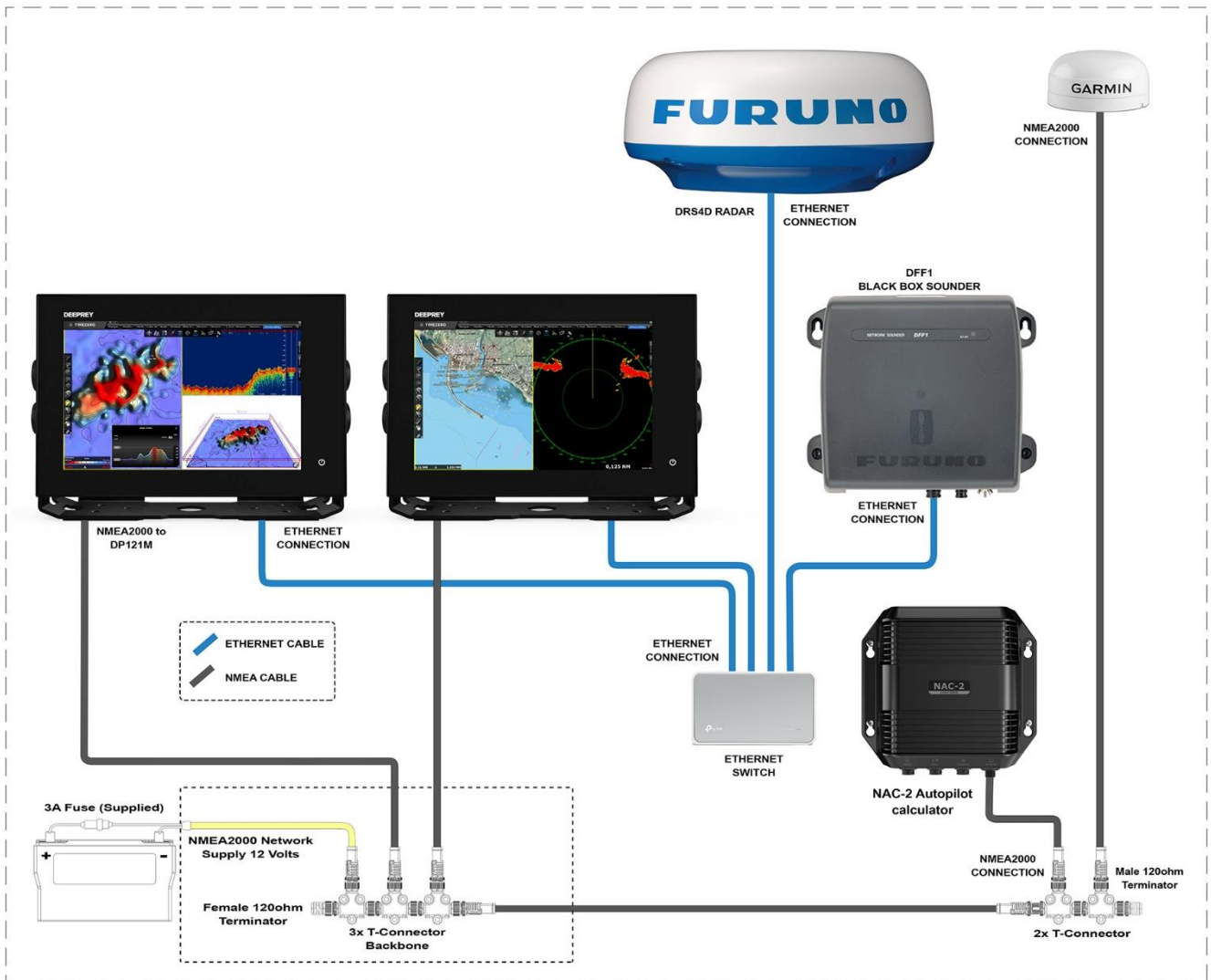

2 EQUIPEMENT LIST

2.1 Standard supply

Name	Qty.	Remarks
Display unit	1	
Power supply	1	
Flush mount tool	1	
Flush mount gasket	1	
Multi-functional cable	1	10POS COM Cable
Operator's manual	1	

2.2 Optional supply

Name	Remarks
NMEA2000 cable	
NMEA2000 T-connector	
NMEA2000 starter kit	

3 INSTALLATION

3.1 Mounting

3.1.1 Place suitable for mounting

When selecting a mounting location, keep the following in mind:

- Mount the equipment where shock and vibration are minimal.

- Keep the equipment away from electromagnetic field generating equipment such as motors and generators.
- The temperature at the mounting location shall be between -15°C and $+45^{\circ}\text{C}$.
- The humidity at the mounting location shall be 91% or less (at 40°C).
- Locate the equipment away from exhaust pipes and exhaust ports.
- The mounting location shall be well ventilated.
- Choose a location that allows easy access for maintenance and inspection. Leave servicing space around the equipment, as shown in the outline drawing at the end of this manual.
- Do not mount the equipment on the overhead.
- A magnetic compass will be affected if the equipment is placed too close to it. Keep the compass safe distance shown in the Safety Instructions.

3.1.2 Flush mount

Read the contents of this section carefully and mount this equipment on a flat surface. Improper mounting may cause failures with the display screen of this equipment.

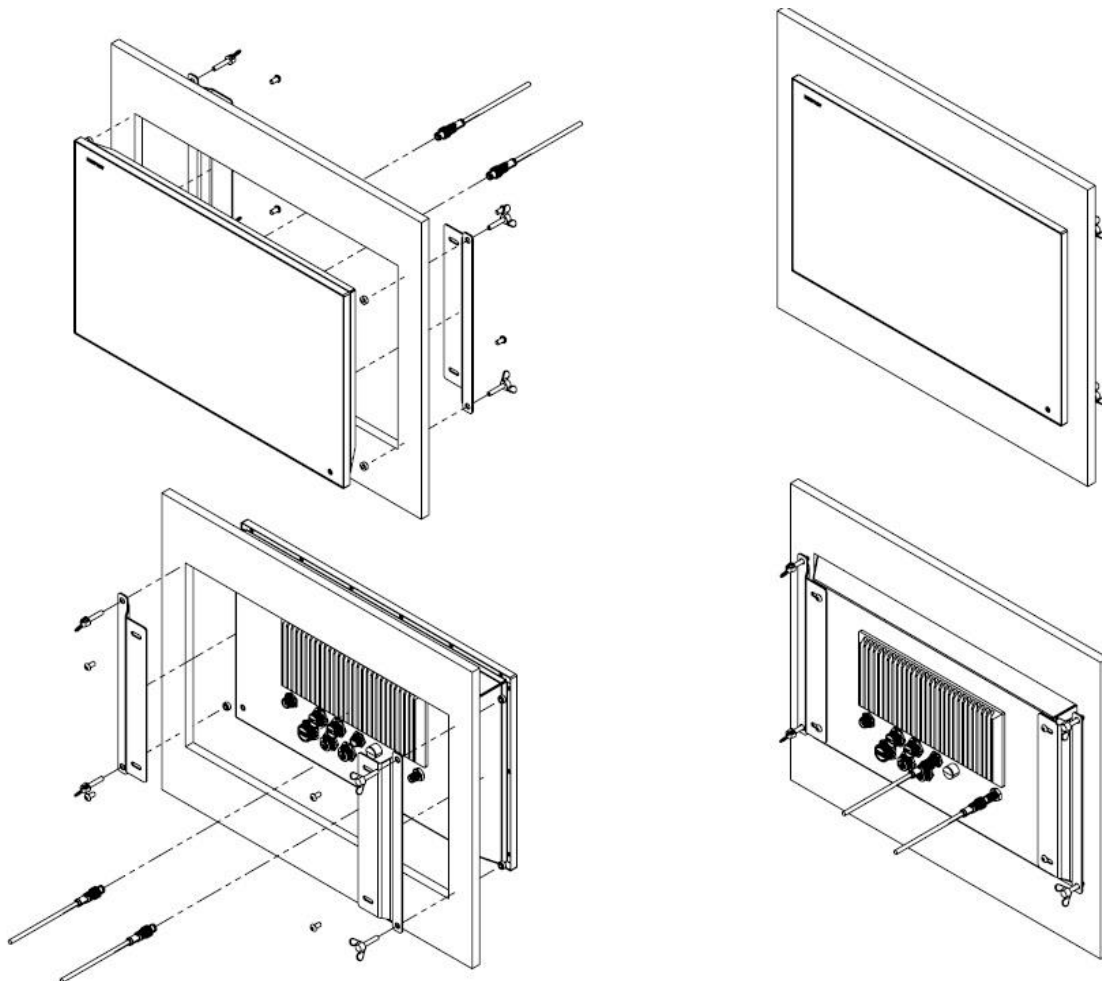

1. Screw the wing bolts onto the two mounting brackets.



2. Check that the mounting surface is flat, even and without curve and make a mounting hole at mounting location by using the enclosed template for DP-MFD.
3. Attach the mounting gasket along the edges of the mounting hole, or to the backside of this equipment.
4. Connect all cables at the rear side of the DP-MFD.

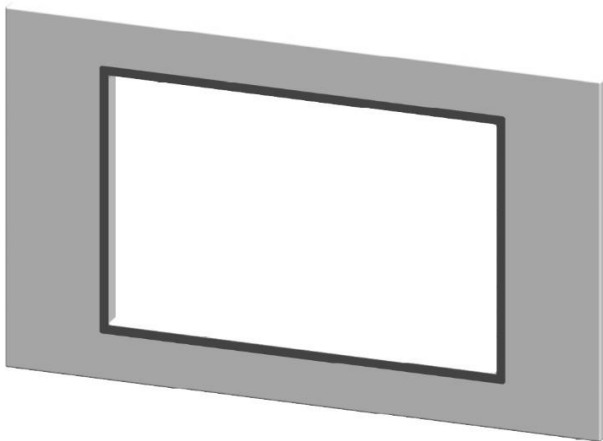

5. Insert the DP-MFD body into the mounting hole made at step 2, and fix flush mounting brackets and main body with bolts (4 pcs). Manually and securely tighten wing bolts (four in total) attached to the flush mounting bracket so that the protector of the flush mounting assembly touches the wall.

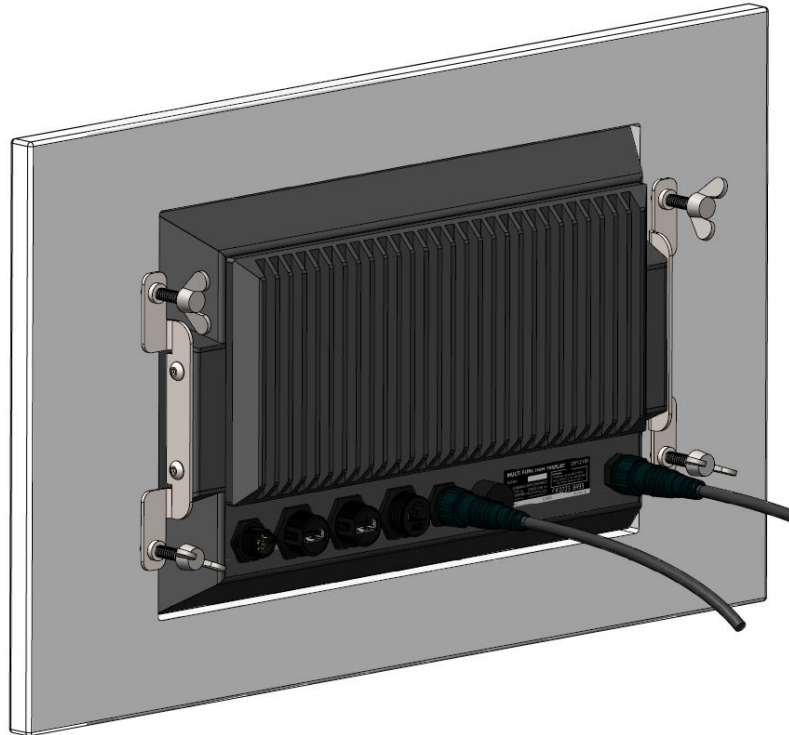

3.2 Wiring

3.2.1 Main body (rear) interface

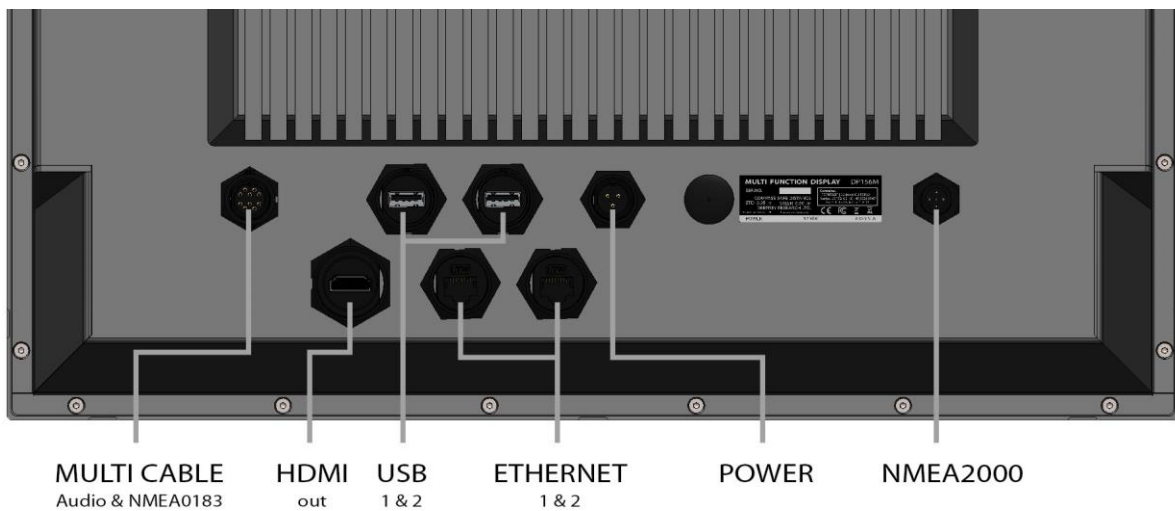

Note:

- Protect unused connectors by covering them with the provided caps.
- To prevent cable and connector deterioration, plug or unplug them carefully

3.2.2 Multi-Functional cable (10POS COM Cable)

Use the multi-functional cable to connect an external powered speaker and two NMEA0183 equipment. The multi cable has 10 core wires.

Refer to the table for pin arrangement on the multi cable

Connector	Color	Remarks			
1	TX_01	Black	Nmea0183_01 Tx	RS232	
2	RX_01	Brown	Nmea0183_01 Rx		
3	TX_02	Red	Nmea0183_02 Tx	RS232	
4	RX_02	Orange	Nmea0183_02 Rx		
5	AUD L+	Yellow	Audio output Left +	Audio outputs	
6	AUD L-	Green	Audio output Left -		Left
7	AUD R+	Blue	Audio output Right +		Right
8	AUD R-	Gray	Audio output Right -		
9	GND_01	White	Nmea0183_01 Ground		
10	GND_02	Pink	Nmea0183_02 Ground		

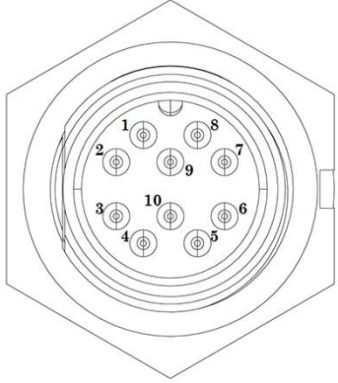

3.2.3 Power connection

1. Locate the power cable included with the DP-MFD MFD.
2. Connect the power cable to the power input on the back of the MFD.
3. Route the other end of the power cable to the vessel's power source (12V or 24V DC), ensuring that the cable is properly secured and protected from damage.
4. Connect the power cable to the power source, observing the correct polarity (red wire to positive, black wire to negative).

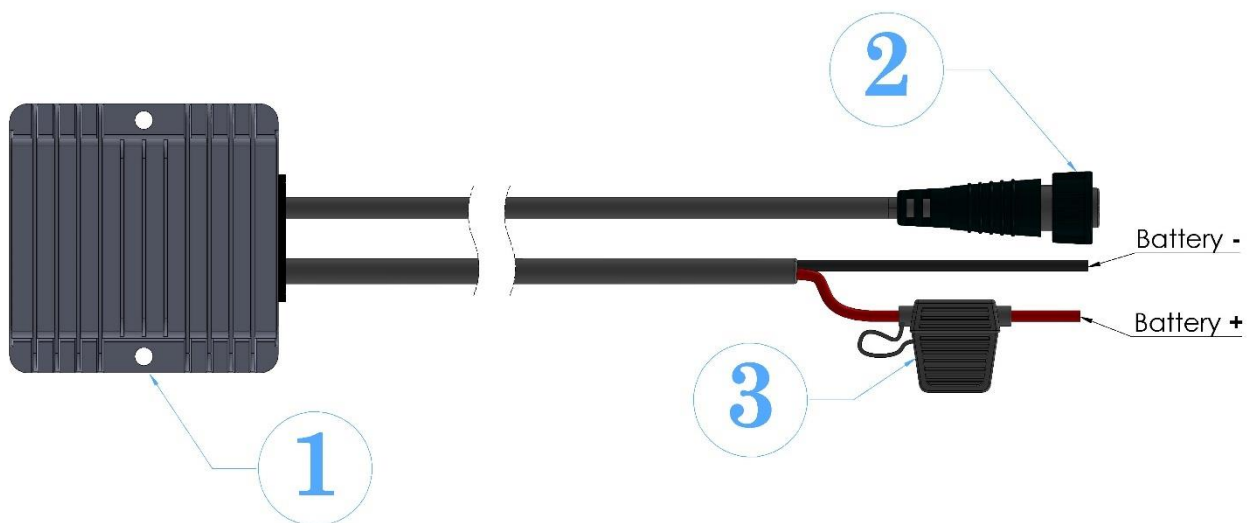

1. DC stabilizer 2. power connector 3. fuse (10 A)

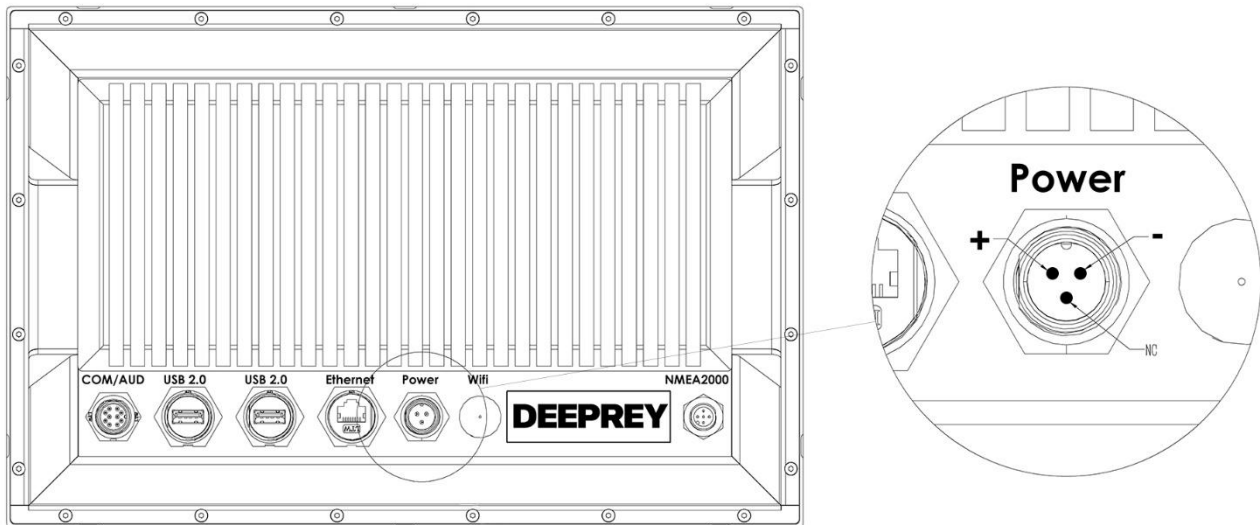

Caution:
 Use the proper fuse.
 Use of an incorrect fuse may damage the equipment.

3.3 NMEA2000 Connector

This connector can share data with NMEA2000 compatible devices.

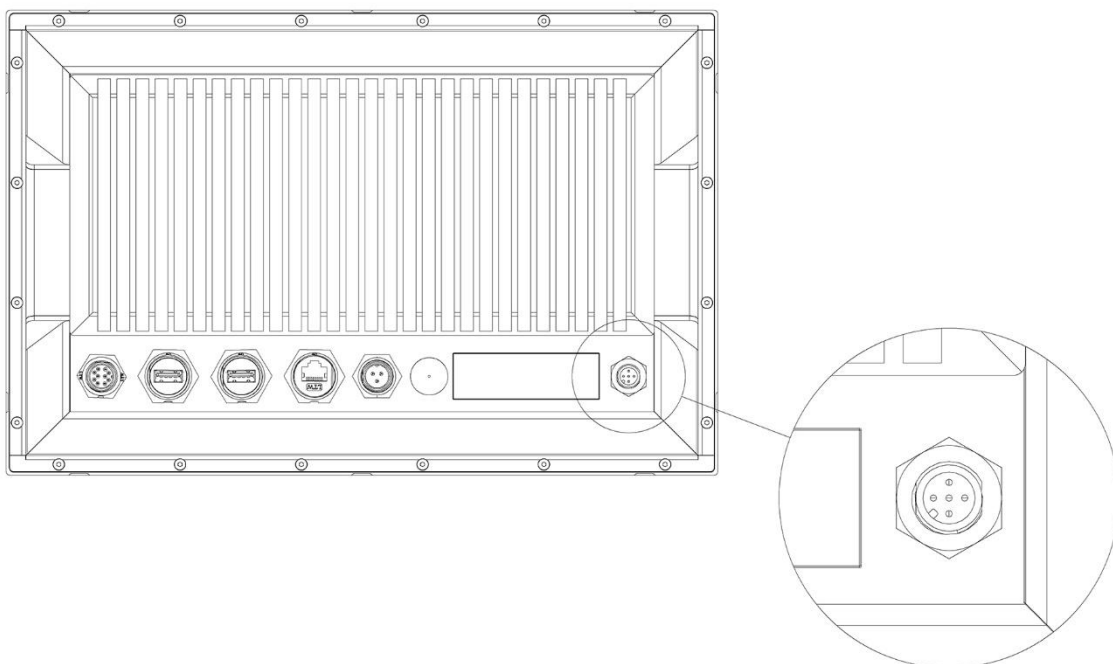

3.3.1 NMEA2000 network connection

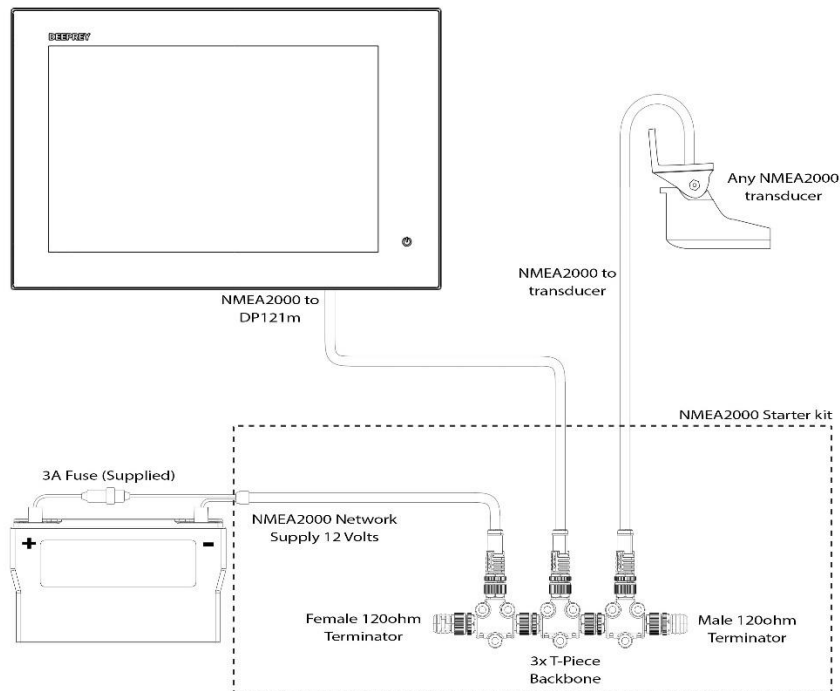

Minimal Equipment Installation Example 1: A Schematic Illustration

- Requires network power source and termination resistor.
- DP-MFD requires 12 VDC. Not adaptive to 24 VDC.

Caution:

Use the proper fuse.

Use of an incorrect fuse may damage the equipment.

3.3.2 NMEA2000 pin definition

Connector	Connector terminal color	Remarks	
1	Shield	Black	Ground reference and shielding
2	VCC	Red	Power supply for the NMEA2000 network
3	Ground	Black	Signal ground reference
4	Can_H	White	High signal of the CAN bus
5	Can_L	Blue	Low signal of the CAN bus

The diagram shows the pinout of the NMEA2000 connector. It is a circular connector with 5 pins. Pin 1 is the shield, pin 2 is VCC, pin 3 is ground, pin 4 is Can_H, and pin 5 is Can_L.

3.4 NMEA2000 PGN

The DP-MFD converts incoming NMEA 2000 PGNs from the input into NMEA 0183 sentences, allowing them to be interpreted by marine software. It also converts data sent by the software back into NMEA 2000 PGNs for output purposes.

3.4.1 Input PGN

PGN	Description	Converted to Nmea 0183 sentences
059392	ISO Acknowledgment	
059904	ISO Request	
060160	ISO Transport Protocol: Data Transfer	
060416	ISO Transport Protocol: Connection Management	
060928	ISO Address Claim	
065240	ISO Commanded Address	
126992	System Time	ZDA
127237	Heading/Track Control	APB
127245	Rudder	RSA, ROR
127250	Vessel Heading	HDG, HDM or HDT*, VHW
127251	Rate of Turn	ROT
127258	Magnetic Variation	HDG
128267	Water Depth	DBT, DPT
128275	Distance Log	VLW
129025	Position, Rapid Update	GGA, GLL, RMC
129026	COG & SOG, Rapid Update	VTG
129029	GNSS Position Data	GGA, GLL, RMC, ZDA
129033	Local Time Offset	ZDA
129038	AIS Class A Position Report	VDM, VDO (AIS VHF Data-link message 1, 2 and 3)
129039	AIS Class B Position Report	VDM, VDO (AIS VHF Data-link message 18)
129040	AIS Class B Extended Position Report	VDM, VDO (AIS VHF Data-link message 19)
129041	AIS Aids to Navigation (AtoN) Report	VDM, VDO (AIS VHF Data-link message 21)

PGN	Description	Converted to Nmea 0183 sentences
129044	Datum	DTM
129283	Cross Track Error	APB, XTE
129284	Navigation Data	APB, BWC, BOD, BWW
129291	Set & Drift, Rapid Update	VDR
129539	GNSS DOPs	GSA
129540	GNSS Sats in View	GSV
129793	AIS UTC and Date Report	VDM, VDO (AIS VHF Data-link message 4)
129794	AIS Class A Static and Voyage Related Data	VDM, VDO (AIS VHF Data-link message 5)
129795	AIS Addressed Binary Message	ABM (AIS VHF Data-link message 6)
129797	AIS Binary Broadcast Message	BBM (AIS VHF Data-link message 8)
129798	AIS SAR Aircraft Position Report	VDM, VDO (AIS VHF Data-link message 9)
129801	AIS Addressed Safety Related Message	VDM, VDO (AIS VHF Data-link message 12)
129802	AIS Safety Related Broadcast Message	VDM, VDO (AIS VHF Data-link message 14)
129809	AIS Class B 'CS' Static Data Report, Part A	VDM, VDO (AIS VHF Data-link message 24)
129810	AIS Class B 'CS' Static Data Report, Part B	VDM, VDO (AIS VHF Data-link message 24)
129811	AIS Single Slot Binary Message	ABM, BBM (AIS VHF Data-link message 25)
129812	AIS Multi Slot Binary Message	ABM, BBM (AIS VHF Data-link message 26)
130306	Wind Data	MDA, MWD, MWV, VWR
130310	Environmental Parameters - DEPRECATED	MDA, MTW
130311	Environmental Parameters - DEPRECATED	MDA, MTW
130312	Temperature - DEPRECATED	MDA, MTW

3.4.2 Output PGN

PGN	Description	Converted from Nmea 0183 sentence
059392	ISO Acknowledgment	
059904	ISO Request	
060928	ISO Address Claim	
126208	Request group function	
126993	Heartbeat	
126996	Product Information	
126998	Configuration Information	

PGN	Description	Converted from Nmea 0183 sentence
129284	Waypoint Arrival Alarm	AAM
129795	AIS Addressed binary and safety related message	ABM
129797		
129811		
129812		
127237	Heading/Track Controller (Autopilot) Sentence 'B'	APB
129283		
129284		
129795	AIS Broadcast Binary Message	BBM
129797		
129811		
129812		
129284	Bearing & Distance to Waypoint (Great Circle)	BWC
128267	Depth Below Transducer	DBT
128267	Depth	DPT
129808	Digital Selective Calling Information	DSC
129808	Expanded Digital Selective Calling	DSE
126992	Global Positioning System Fix Data	GGA
129025		
129029		
129033		
126992	Geographic Position Latitude/Longitude	GLL
129025		
129029		
129033		
129029	GNSS DOP and Active Satellites	GSA
129539		
129547	GNSS Pseudo range Error Statistics	GST
129540	GNSS Satellites in View	GSV
127250	Heading, Deviation & Variation	HDG
127258		
127250	Heading, Magnetic	HDM
127250	Heading, True	HDT

PGN	Description	Converted from Nmea 0183 sentence
127237	Heading Steering Command	HSC
130306	Meteorological Composite	MDA
130310		
130311		
130312		
130310	Water Temperature	MTW
130311		
130312		
130306	Wind Direction & Speed	MWD
130306	Wind Speed and Angle (Relative/Theoretical)	MWV
129283	Recommended Minimum Navigation Information	RMB
129284		
126992	Recommended Minimum Specific GNSS Data	RMC
127250		
127258		
129025		
129026		
129029		
129033		
127251	Rate Of Turn	ROT
127488	Revolutions	RPM
127245	Rudder Sensor Angle	RSA
130578	Dual Ground/Water Speed	VBW
129038, 129039, 129040	AIS VHF Datalink Message: 1, 2, 3, 4, 5, 6, 8, 9, 12, 14, 18, 19, 21, 24, 25, 26	VDM AIS VHF Datalink Message: 1, 2, 3, 4, 5, 6, 8, 9, 12, 14, 18, 19, 21, 24, 25, 26
129794, 129795, 129797		
129802, 129809, 129810		
129041, 129793, 129811		
129798, 129801, 129812		
129038, 129039, 129040	AIS VHF Datalink Own vessel report: 1, 2, 3, 4, 5, 6, 8, 9, 12, 14, 18, 19, 21, 24, 25, 26	VDO AIS VHF Datalink Own vessel report: 1, 2, 3, 4, 5, 6, 8, 9, 12, 14, 18, 19, 21, 24, 25, 26
129794, 129795, 129797		
129802, 129809, 129810		
129041, 129793, 129811		
129798, 129801, 129812		

PGN	Description	Converted from Nmea 0183 sentence
129291	Set and Drift	VDR
127250	Water Speed and Heading	VHW
128259		
128275	Dual Ground/Water Distance	VLW
129026	Course Over Ground and Ground Speed	VTG
130306	Relative (Apparent) Wind Speed and Angle	VWR
129283	Cross Track Error, Measured	XTE
126992		

4 BASIC OPERATION

4.1 Controls

The DP-MFD is equipped with a touchscreen and a touch button for powering the device on or off.

4.1.1 Power button

Upon powering up the DP-MFD, the power button illuminates in orange, indicating that the device is in standby mode. A two seconds touch of the power button activates the device, and the power button LED turns off.

To shut down the device, press the power button for two seconds; this will initiate the shutdown procedure. If you maintain the touch for more than 7 seconds, the device will enter a forced shutdown mode and power off (not recommended). This manual procedure is intended for Windows.

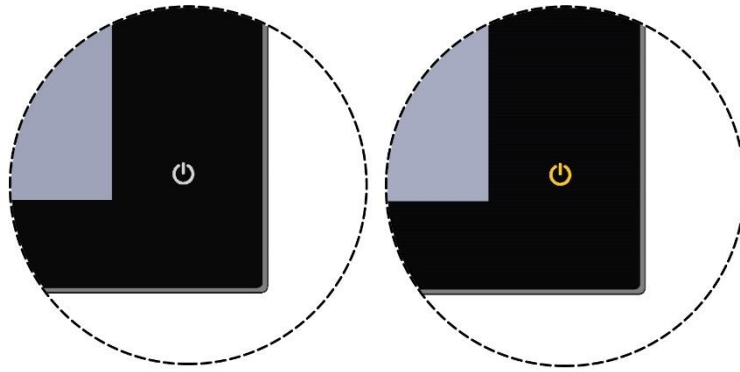
**Note:**

You can change the default action of the power button:



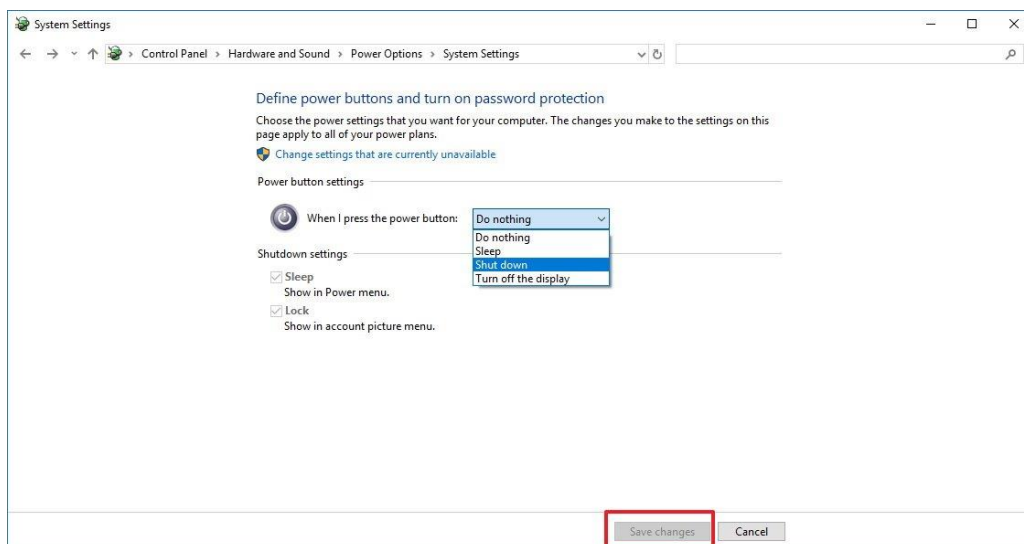





3. Open [Control Panel].
4. Click on [System and Security].
5. Under "*Power Options*," click the [Change what the power buttons do] link.
6. Using the drop-down menu for "*When I press the power button*" select the action you want:
 - *Do nothing.*
 - *Sleep.*
 - *Hibernate.*
 - *Shut down.*
 - *Turn off the display.*
7. Click the [Save changes] button at the bottom of the window.



Once you completed the steps, every time you press the power button your computer will respond to the new action.

4.1.2 Touch control

A finger or two are used for touch control. The basic operations are as shown below.

	Touch control	Function
 RIGHT SWIPE	Slide your finger across the screen to the right side.	Scroll or pan quickly
 LEFT SWIPE	Slide your finger across the screen to the left side.	Scroll or pan quickly
 DOUBLE SWIPE	Perform a double-finger swipe across the screen.	Show your desktop, view all open windows, or switch applications
 PINCH	Touch surface with two fingers and bring them closer together	Scale down
 SPREAD	Touch surface with two fingers and move them apart.	Scale up
 ROTATE	Perform a two-finger rotation across the screen.	Adjust view (rotate)
 TAP	Briefly touch surface with fingertip.	Select
 DOUBLE TAP	Rapidly touch surface twice with fingertip.	Adjust view (zoom in)
 PRESS HOLD	Touch surface for extended period of time	Display commands

Notes for touch control:

- A large amount of waterdrops on the screen can cause improper operation. Waterdrops on the screen can cause slow touch response. Wipe the screen to remove the waterdrops before use.
- This equipment uses a capacitive touch screen. Tap the screen with your fingertips directly. Do not use sharp objects (needle, pen, nail) or a stylus pen. Also, be careful not to scratch the screen.
- Tapping the screen with gloved fingers may cause improper operation.
- Do not operate the equipment with objects placed on the screen. The touch control can fail to work properly if objects other than fingertips are touching the screen.
- Keep the equipment away from a radio antenna, fluorescent light, solenoid valve or other electronic devices to prevent false operation from noise.
- The panel is made of glass. If the panel is cracked or damaged, do not touch it or try to repair it yourself. Damage caused by improper handling will void the warranty.

4.2 Adjust Brightness

How to adjust the brilliance of display:

1. Select the **Notifications** icon in the bottom-right corner of the screen to open the **Action Center**.
2. Select **Expand** in the **Action Center**.

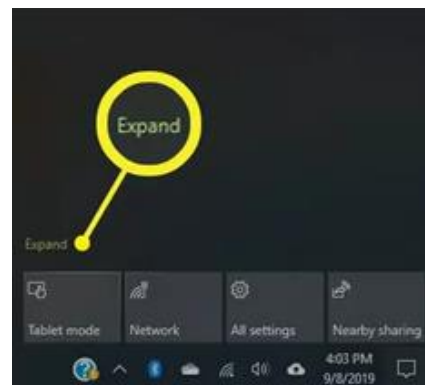
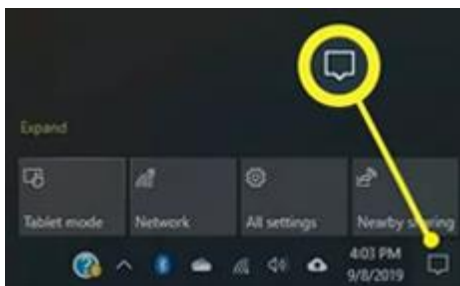

3. Press the brightness button with the sun icon on it to cycle through five preset screen brightness levels or drag the slider next to the sun icon. The lowest possible brightness setting is 0 percent, while 100 percent is the highest.

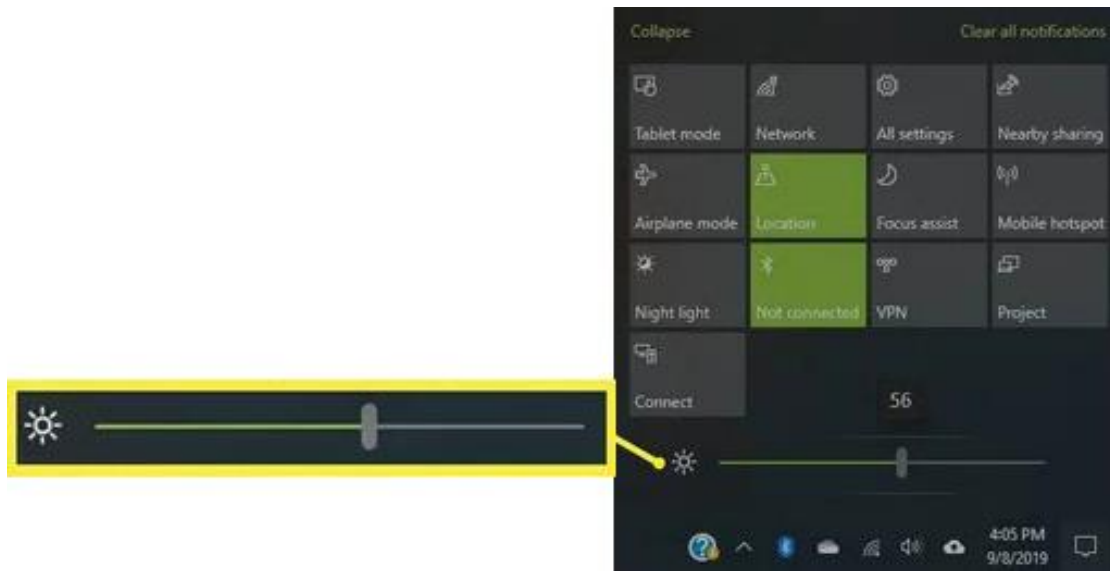

- Exit the Action Center to save the setting.

5 TECHNICAL SPECIFICATIONS

Display	
DISPLAY SIZE	DP185XL : 18.5 inch DP215XL : 21.5 inch
BRIGHTNESS (CD/M ²)	1000 cd/m ² sunlight readable
TOUCHSCREEN	Yes
TOUCHSCREEN TYPE	Project Capacitive Touch (10 points)
DISPLAY RESOLUTION	HD 1920x1080 pixels
ASPECT RATIO	16:9
SUPPORT COLOR	16.7M colors
DISPLAY MODE	IPS wide-view

Embedded System	
CPU	10th Gen Intel® Processor up to 2.60 GHz
MEMORY	8Gb DDR4
HARD DRIVE CAPACITY	256Gb SSD
GRAPHICS	Intel® UHD Graphics for 10th Gen Intel® Processors
AUDIO	High-Definition Audio Codec (HD), Line out x 2
VIDEO	1 x HDMI out
NETWORK	Intel® Gigabit Ethernet controller
WIRELESS NETWORK	WIFI 2,4 GHz
I/O INTERFACE	2×USB 2.0
	2 x COM RS232
	Nmea 2000
OPERATION SYSTEM	Windows 10 pro

CONNECTIONS	
NMEA 2000® PORTS	1
CONNECTIONS NMEA0183 INPUT PORTS	2
NMEA 0183 INPUT PORTS	2
ETHERNET NETWORK PORTS	2
USB (2.0)	2

MECHANICAL SPECIFICATIONS	
MATERIAL	100 % Aluminium Alloy
COLOR	Black
IP GRADE	IPX6*
DIMENSION	DP185XL :
	DP21XL : 20.55 x 12.68 x 2.56 inches (52.2 x 32.2 x 6.5 cm)
MOUNTING OPTIONS	Flush
WEIGHT	DP185XL : 13.2 lbs (6 kg)
	DP215XL : 14.3 lbs (6.5 kg)

ELECTRICAL SPECIFICATIONS	
POWER INPUT	12 VDC (10V to 36 V with DEEPREY Power Cable 6A2)
TYPICAL CURRENT DRAW AT 12 VDC	2.0 A
MAXIMUM CURRENT DRAW AT 12 VDC	4.5 A

MAXIMUM POWER USAGE AT 12 VDC	54W
-------------------------------	-----

OPERATING ENVIRONMENT	
TEMPERATURE RANGE	Operating: -10 to 45°C, storage: -20 to 80°C
RELATIVE HUMIDITY	5%~95% @ 40° C, non-condensing
VIBRATION	5-500 Hz, 0.026 G ² /Hz, 2.16 Grms

(*)

6 BIOS SETUP

6.1 Entering the BIOS

Turn on the DP-MFD and press <Delete> key to enter the BIOS settings.

If the computer has been turned on, continuously press the <F11> key, then select "Enter Setup."

BIOS Hotkeys		
F9	F10	ESC
restore to factory settings	save changes and exit	exit the BIOS without saving changes

6.2 Main setup

Upon entering the BIOS Setup utility, your initial encounter will be with the Main Setup screen. Displayed below is the Main BIOS Setup screen. You can easily navigate back to the Main setup by choosing the Main tab.

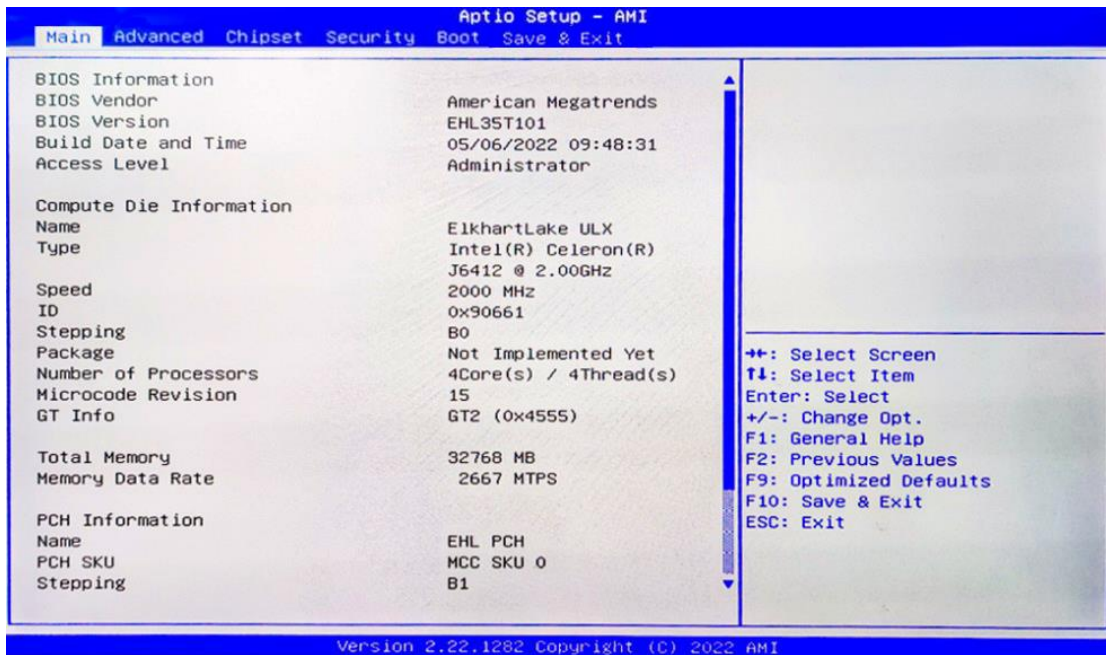

System Date: Adjusts the date using the MM/DD/YY format.

System Time: Configures the time using the HH:MM:SS format.

6.3 Advanced settings

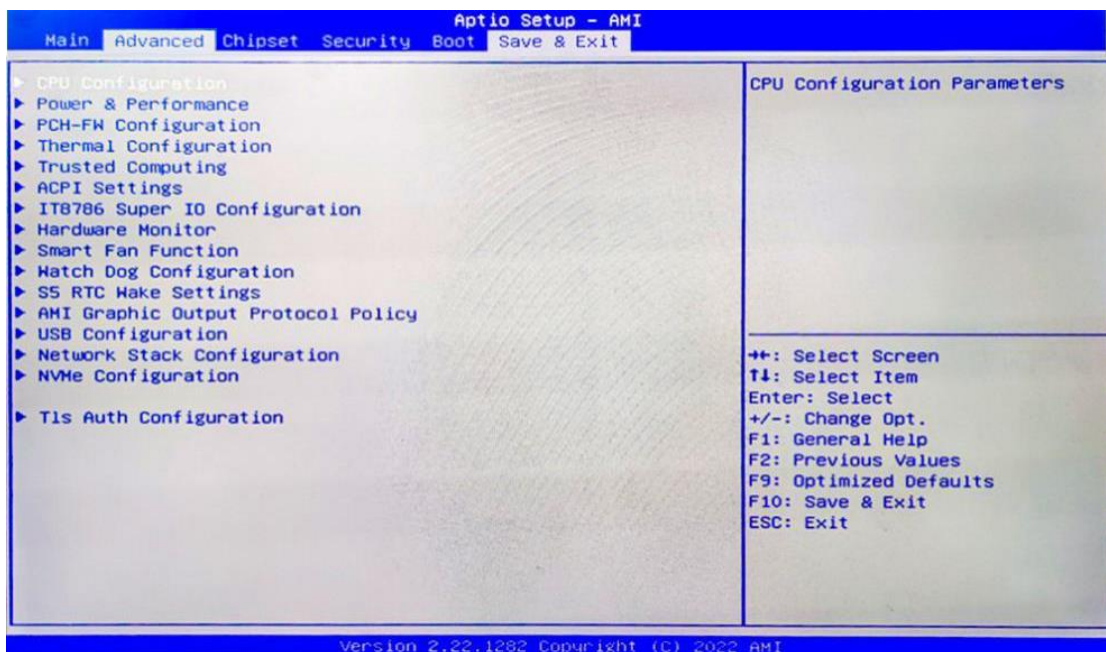

Select any of the items in the left frame of the screen. The advanced sections allow you to configure, improve and set up system features according to the preference of the CPU Configuration. All Advanced BIOS Setup options are described as follows.

6.3.1 Power and performance

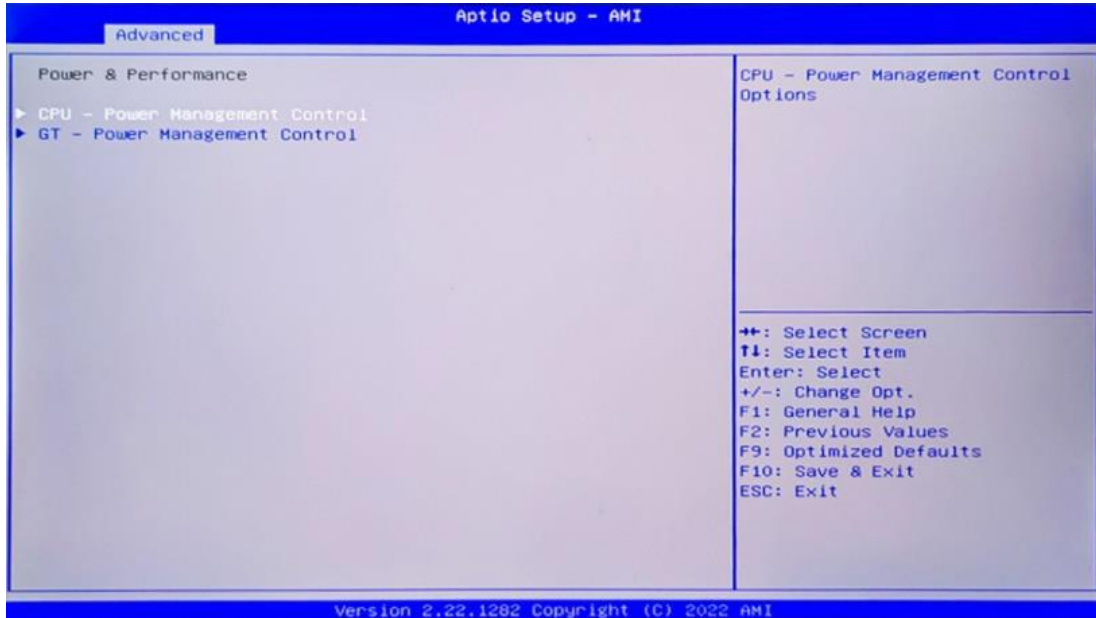

CPU-Power Management Control
 GT-Power Management Control

6.3.2 CPU-Power Management Control

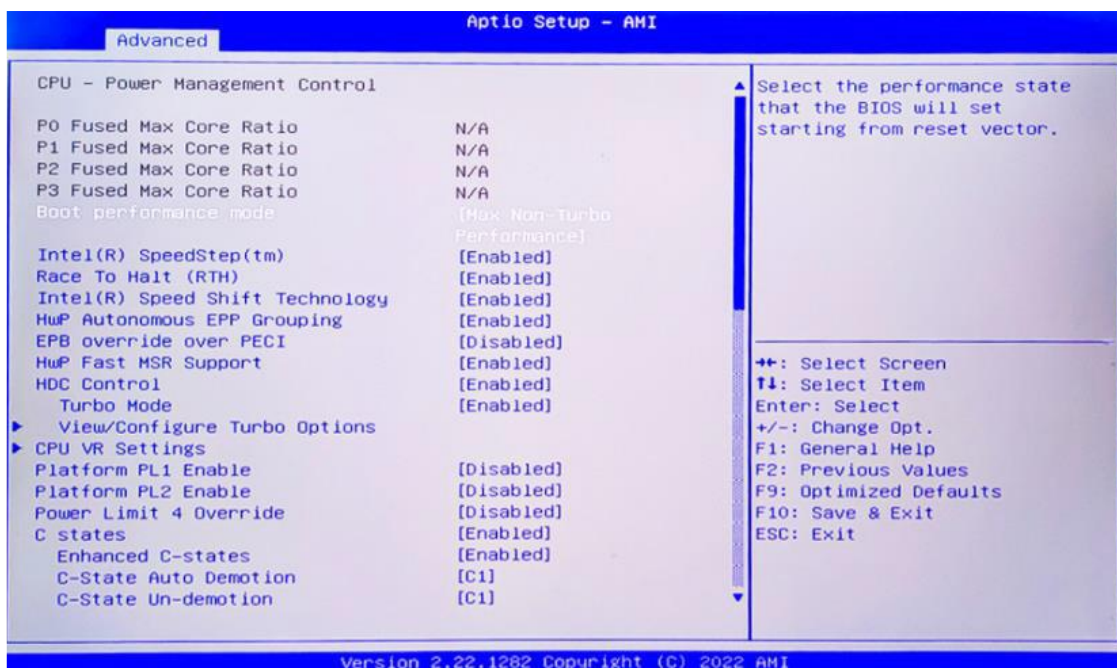

Intel® SpeedStep®(TM):

Enhanced Intel SpeedStep® Technology enables the operating system to control multiple frequencies and voltage points for optimal performance and power efficiency.

Intel® Speed Shift Technology:

An energy-efficient frequency control method by the hardware rather than relying on OS control. Processor decision is based on the different system constraints for example Workload demand, and thermal limits while taking into consideration the minimum and maximum levels and activity window of performance requested by the operating system. Default enabled.

Turbo Mode:

The Turbo mode refers to Nehalem's "Integrated Power Gate" power management technology, which allows running off some cores and adding power to the others so that they run at a higher frequency. The capacity of the entire CPU remains unchanged, and the efficiency of the CPU is optimized. Default enabled.

C states:

Idle States (C-states) are used to save power when the processor is idle. C0 is the operational state, meaning that the CPU is doing useful work 100% load. C1 is the first idle state, C2 the second, and so on, where more power-saving actions are taken for numerically higher C-states. C1 to C3 cuts off the clock inside the CPU, and C4 to C6 reduces the CPU voltage. Default enabled.

Enhanced C states:

C1 to C3 cuts the clock inside the CPU. C4 and C6 mode reduces CPU voltage. Features two way "Enhanced" mode, enable by default.

6.3.3 GT-Power Management Control

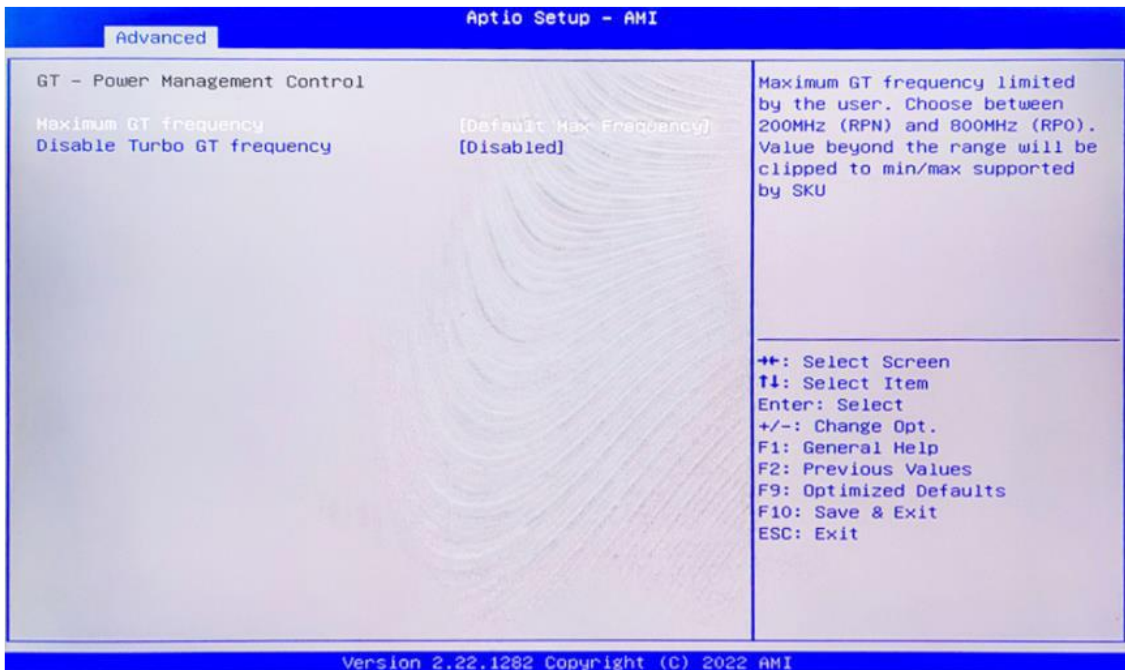

Maximum GT frequency:

Maximum GT Frequency, Default max frequency.

Disable Turbo GT frequency:

Disable Turbo GT Frequency mode, Default disabled.

6.3.4 Thermal Configuration

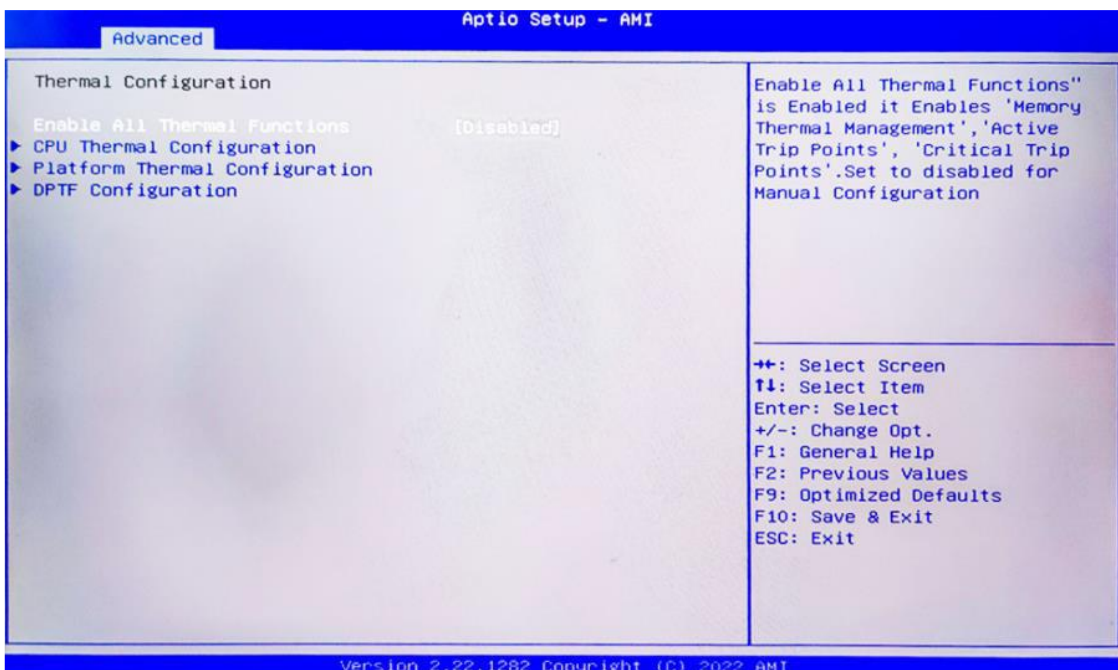

Enable All Thermal Functions

CPU Thermal Configuration:

Unlocks the temperature setting, the "Tcc Activation Offset" is the temperature adjustment option, the highest temperature is 105°C. Change the temperature by minus the number of degrees you wish to change. For example, minus 0(105-0) to set the temperature at 105°C, minus 20(105-20) to set the temperature at 85°C.

Platform Thermal Configuration

DPTF Configuration

6.3.5 ACPI Settings

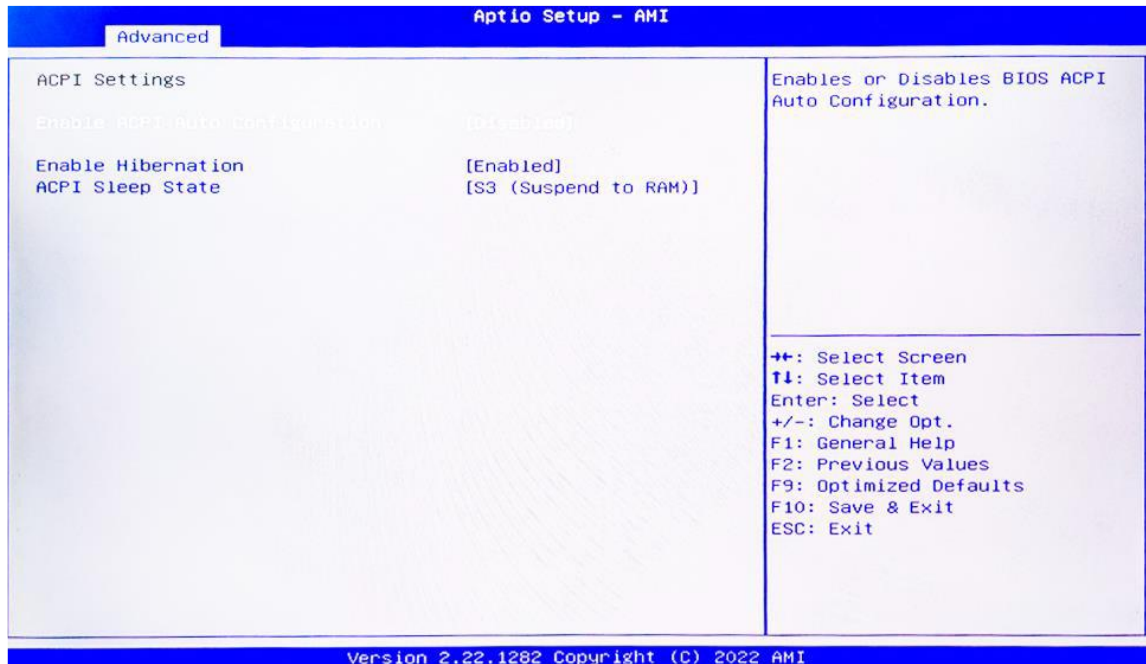

Enable ACPI Auto Configuration

Enable or disable BIOS ACPI Auto Configuration.

Enable Hibernation

Enable or disables the ability to hibernate.

ACPI Sleep State

Select the highest ACPI sleep state the system will enter when the SUSPEND button is pressed.

6.3.6 IT8786 Super IO Configuration

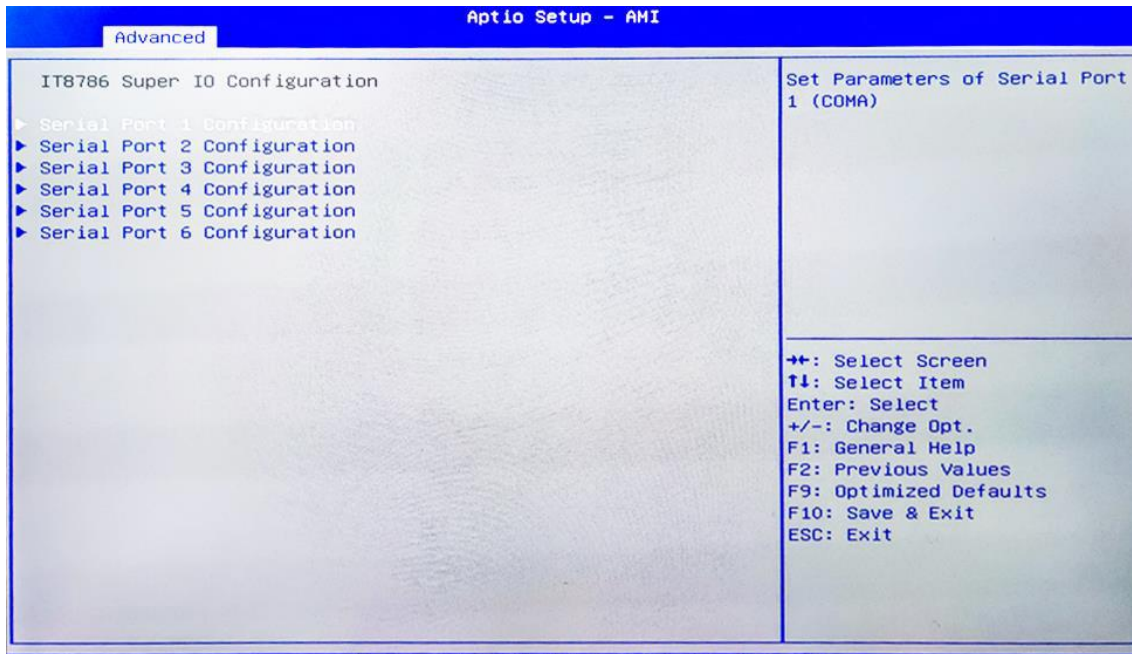

Serial Port 1 Configuration

Set parameters of serial port 1.

Serial Port 2 Configuration

Set parameters of serial port 2.

Serial Port 3 Configuration

Set parameters of serial port 3.

Serial Port 4 Configuration

Set parameters of serial port 4.

Serial Port 5 Configuration

Set parameters of serial port 5.

Serial Port 6 Configuration

Set parameters of serial port 6.

Serial Port: Enable or disable serial port (COM).

Device Setting (Read-only): Displays serial ports' interrupt and location.

Change Setting: Change serial port settings and suggest setting "Auto" as default.

6.3.7 Hardware Monitor

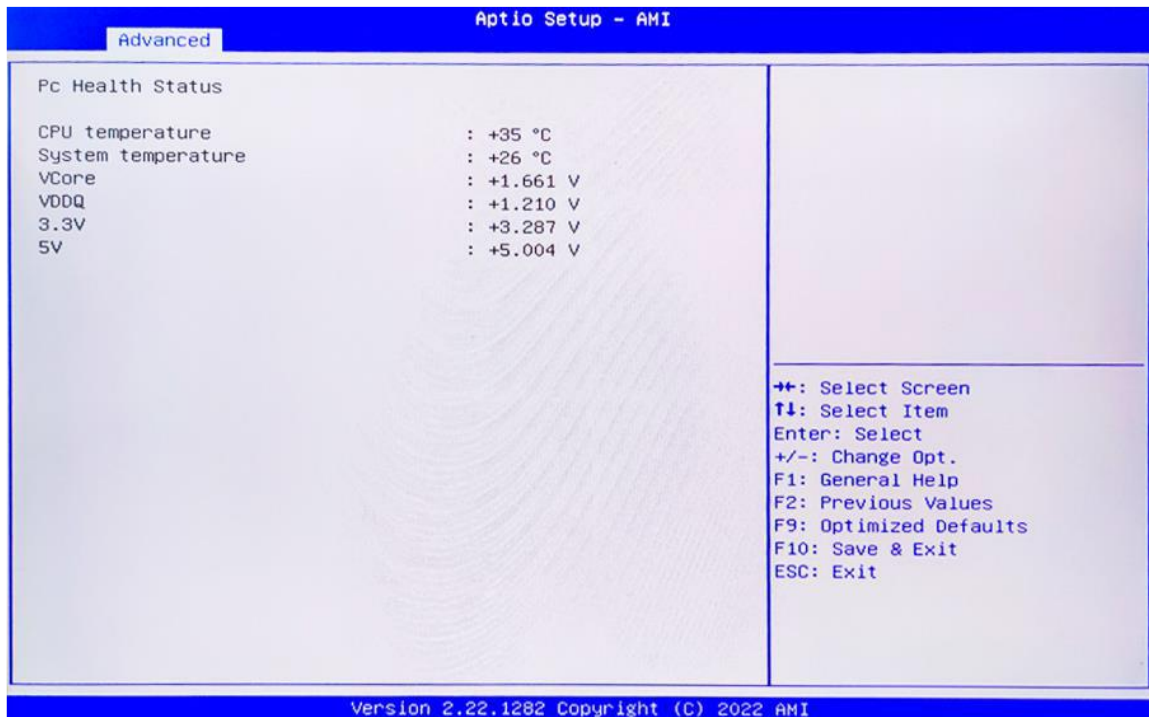

PC Health Status

The PC health status displays CPU temperature, system temperature, fan speed, and other relevant voltage values. The above parameters have a certain range, and the system cannot run beyond these ranges.

- CPU Temperature
- System Temperature
- VCore: Core Voltage
- VDDQ: RAM Voltage
- +3.3V: 3.3V
- +5V: 5V

6.3.8 Smart Fan Function

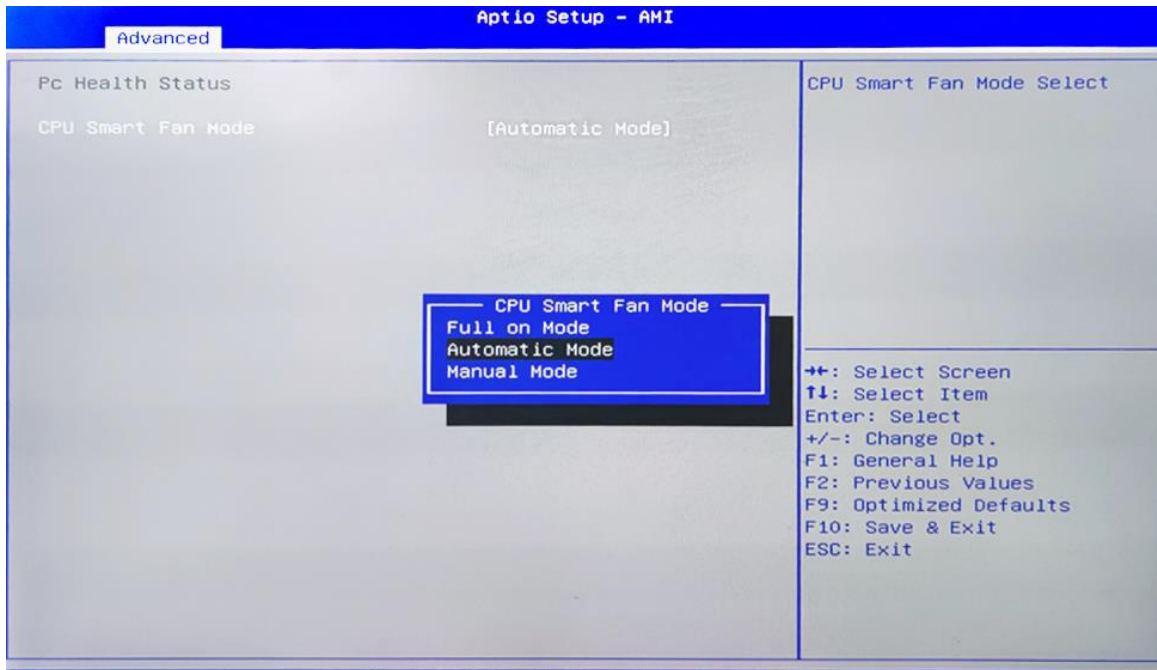

Smart Fan Mode:

- Automatic Mode
- Full-on Mode
- Manual Mode

6.3.9 Watch Dog Configuration

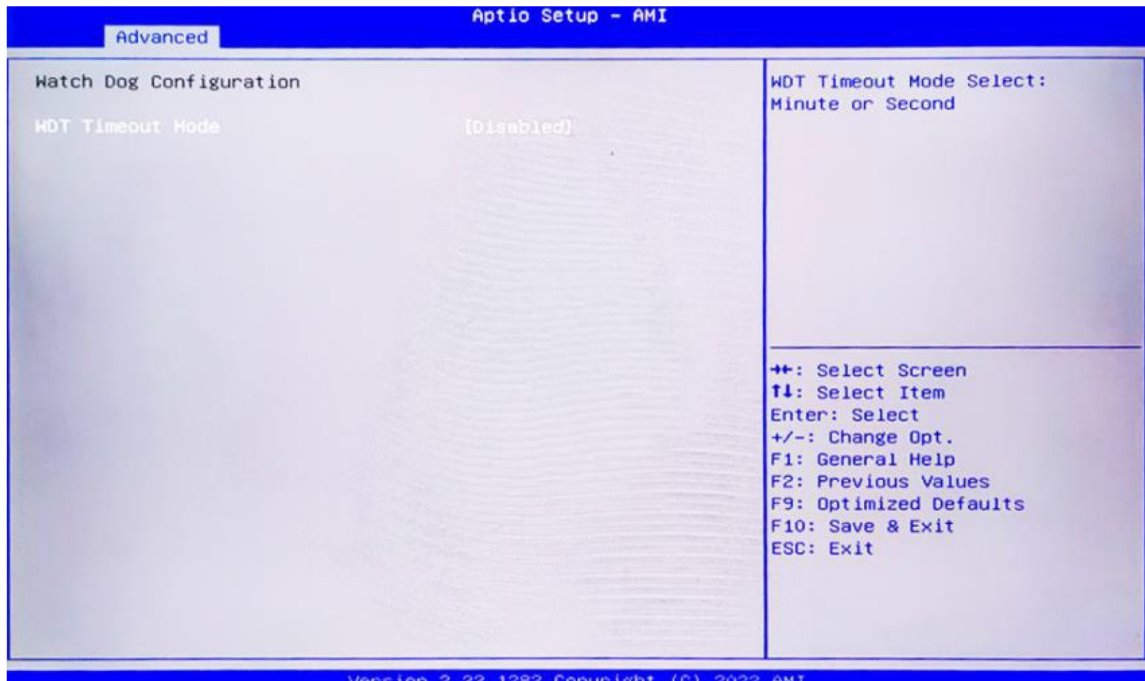

Watch Dog Configuration

WDT Timeout Mode select: Minute or Second

6.3.10 S5 RTC Wake Settings

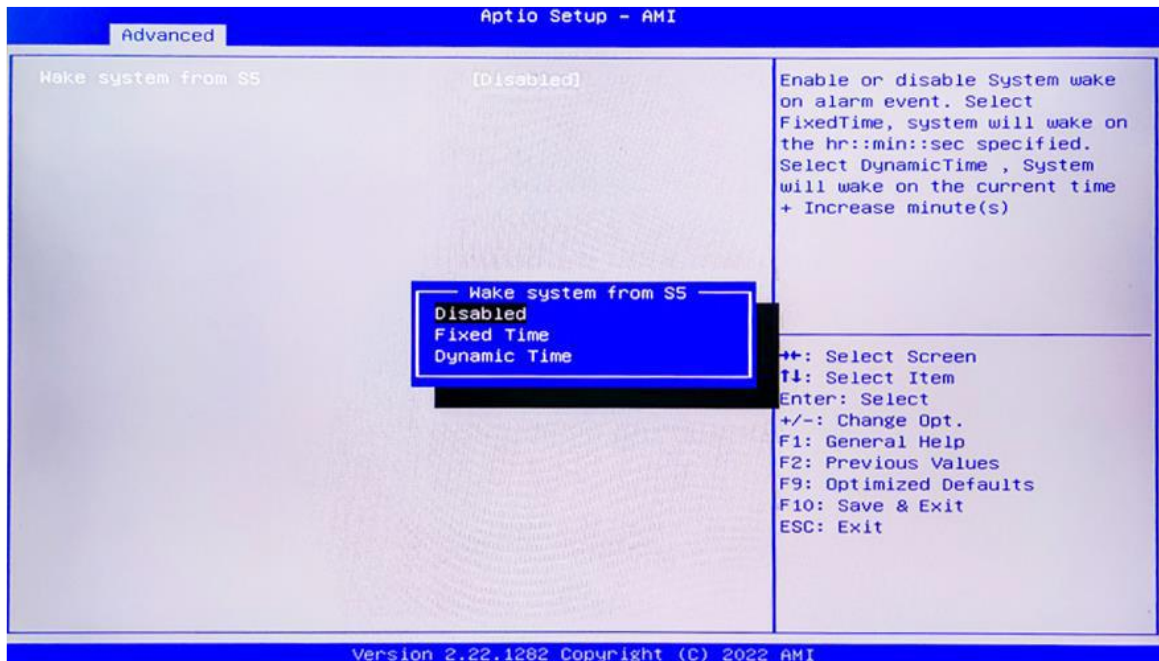

Wake System from S5: timing boot settings, disabled by default.

Fixed Time: Select Fixed Time and the system will wake on the Hr: Min: Sec specified.

Dynamic Time: Select Dynamic Time and the system will wake on a dynamic time.

6.3.11 USB Configuration

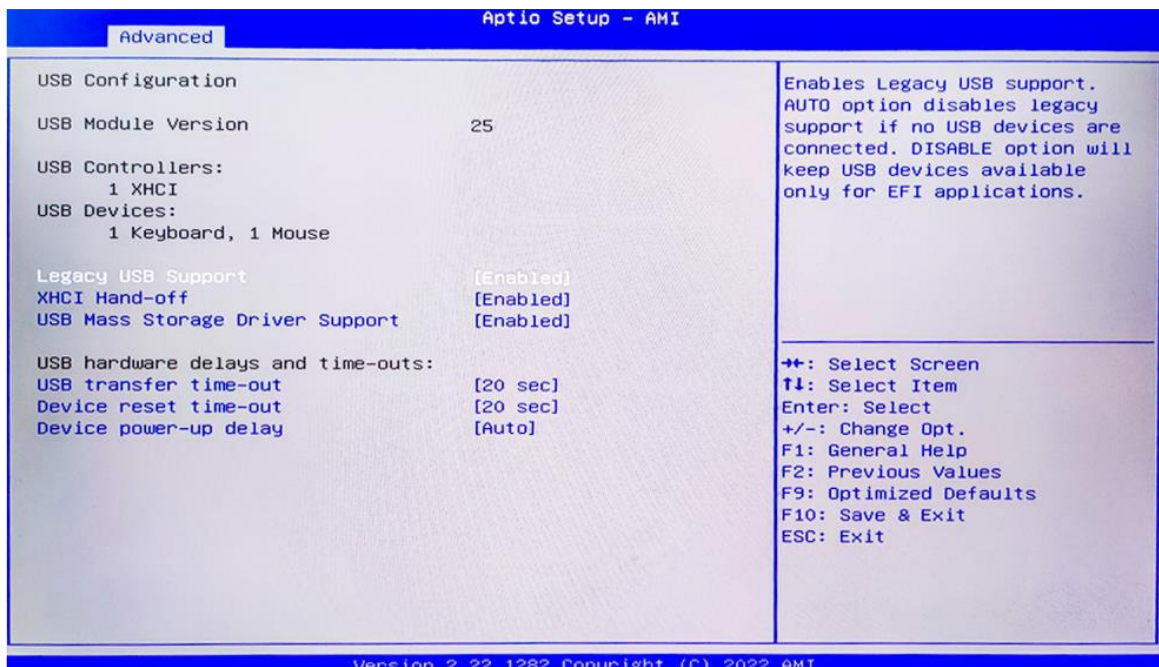

Legacy USB Support

Enable Legacy USB support. Disables legacy support if no USB devices are connected. Select enable will keep USB devices available under UEFI's support.

XHCI Hand-off

A workaround for OS without XHCI hand-off support. The XHCI ownership change should be claimed by the USB XCHI driver.

USB Mass Storage Driver Support

Enable(default) or disable USB Mass Storage Driver Support.

USB transfer time-out

Time-out value for control, bulk, and interrupt transfers, default time:20 second.

Device reset time-out

USB mass storage device start unit command time-out, default time:20 second.

Device Power-up Delay

Maximum time the device will take before it properly reports itself to the host controller.

6.3.12 Network Stack Configuration

**Network Stack**

PXE Network boot setting, disabled by default.

6.3.13 NVMe Configuration

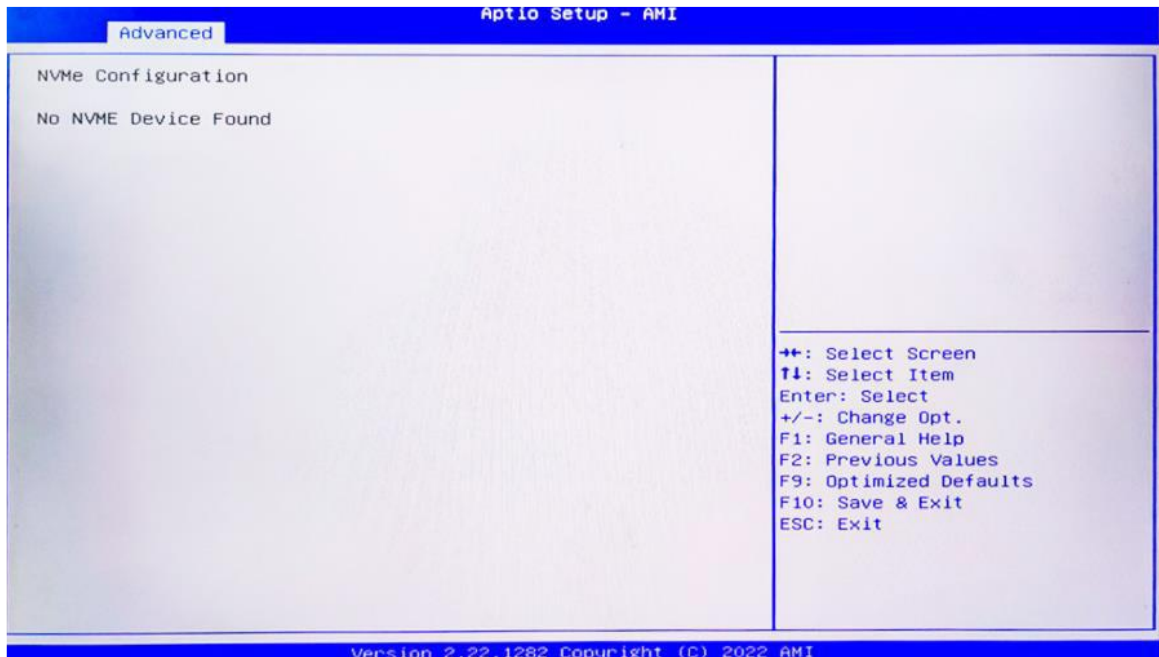

The capacity and model of the SSD will be displayed under the option after the NVMe protocol SSD has been installed.

6.4 Chipset

Select the chipset tab from the setup screen to enter the chipset BIOS Setup screen.

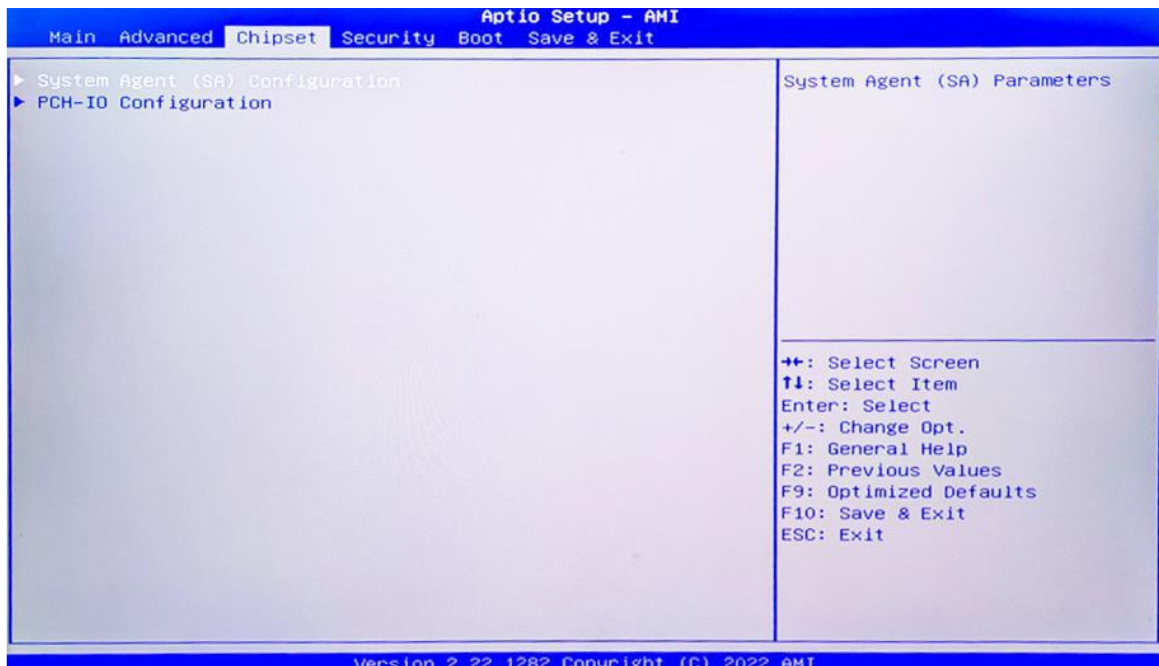

System Agent (SA) Configuration: Northbridge configuration options, including video memory, display devices, and other options.

PCH-IO Configuration: Southbridge configuration options, including hard disk, sound card equipment, and other options

6.4.1 State After G3

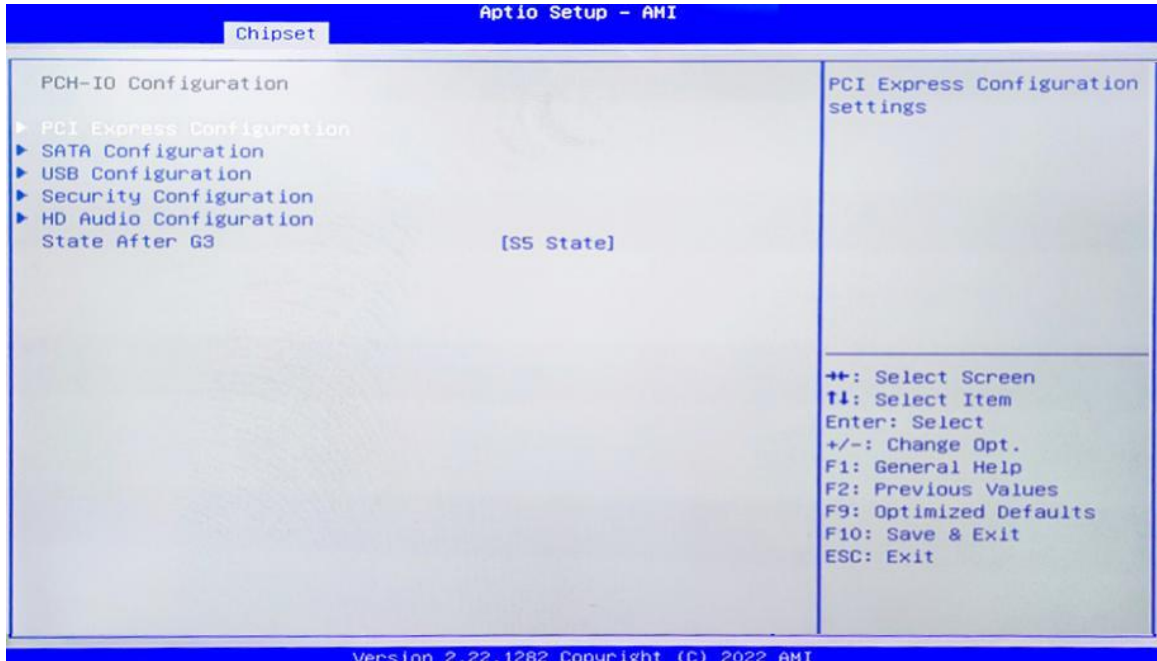

State After G3 is set to S0 State (auto-start after power-on)

6.5 Security

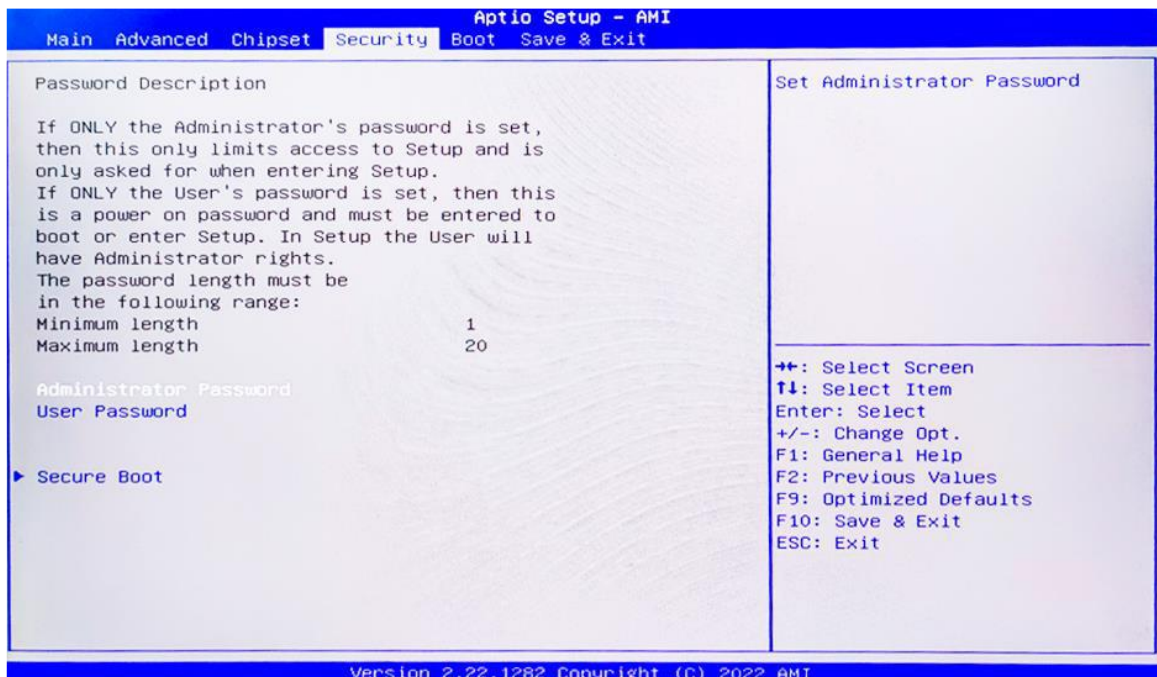

Administrator Password: Set the Administrator Password.

User Password: Set User Password.

Secure Boot: Secure boot

6.6 Boot

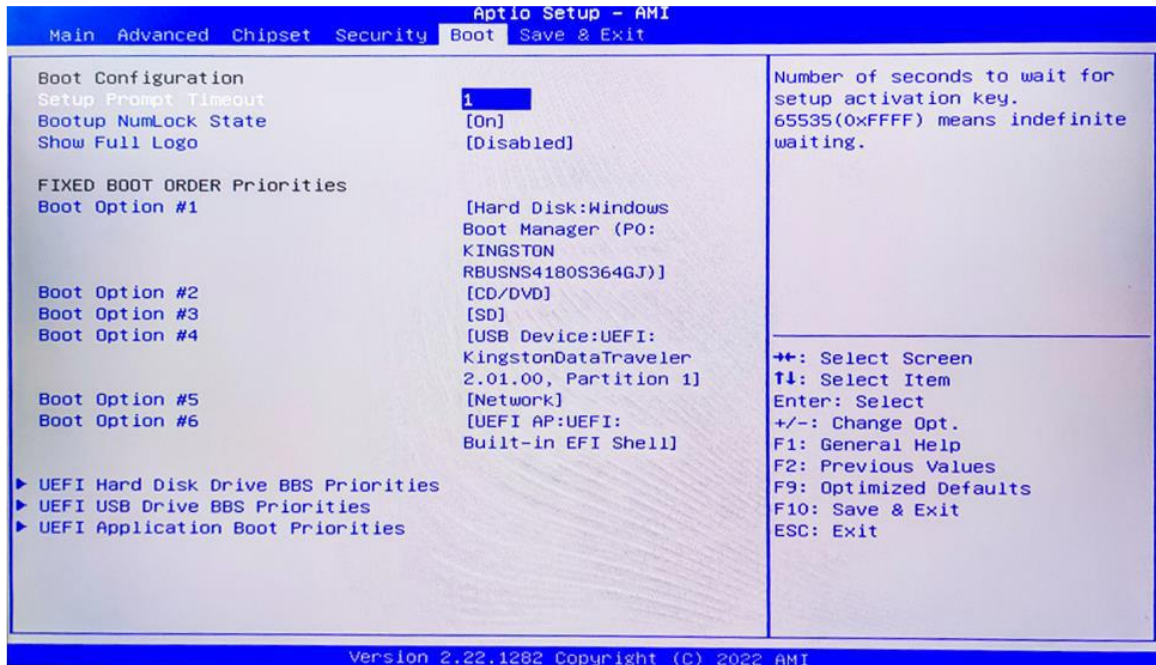

Setup Prompt Timeout:

Number of seconds that the firmware will wait before initiating the original default boot selection. A value of 0 indicates that the default boot selection is to be initiated immediately on boot. A value of 65535(0xFFFF) indicates that firmware will wait for user input before booting. This means the default boot selection is not automatically started by the firmware.

Bootup NumLock State:

Select the keyboard NumLock state

Show Full Logo:

Enabled/Disabled Displays customized boot logo.

Boot Option #1~#6:

Set the system boot order from Number 1 to Number 6.

UEFI Hard Disk Drive BBS Priorities:

UEFI hard drive boot priorities setting.

UEFI USB Drive BBS Priorities:

UEFI USB device boot priorities setting.

UEFI Application boot Priorities:

UEFI application boot priority.

6.7 Save and exit

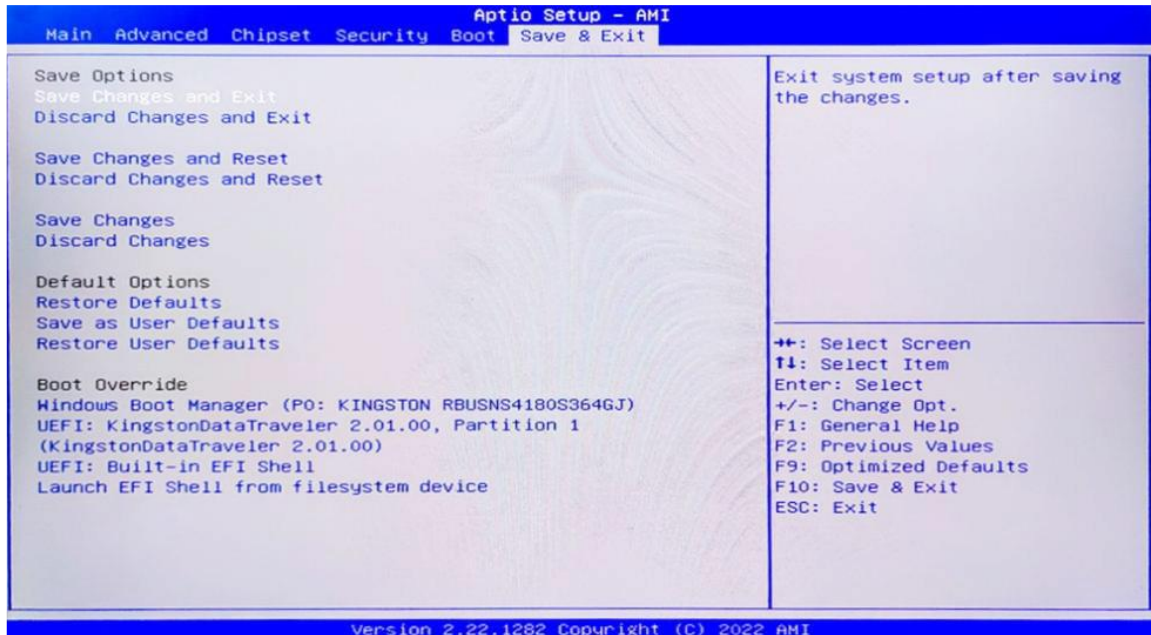

Save Changes and Exit:

Exit the system setup after saving the changes and continue to start the computer.

Discard Changes and Exit:

Exit the system setup without saving any changes and continue to start the computer.

Save Changes and Reset:

Reset the system after saving the changes.

Discard changes and Reset:

Reset the system without saving any changes.

Save Changes:

Save changes done so far to any of the options.

Discard Changes:

Discard changes done so far to any of the options.

Restore Defaults:

Restore/load default values for all the options.

Save as User Defaults:

Save the changes done so far as the user defaults.

Restore User Defaults:

Restore the user defaults to all the options.

Boot Override:

Boot device selection can override your boot priority. Select the specified boot device such as SATA, USB Flash Disk, EFI Shell, PXE, etc., and boot directly. Or press F11 boot by selecting the specified boot device.

6.8 Steps for EHL35V20 LVDS Adjustment under the BIOS

Press the DEL key entering the BIOS, and use the arrow keys to move around and select Chipset. Then select the "System Agent (SA) Configuration". Press Enter as shown below:



Select "Graphics Configuration" Press Enter as shown below:

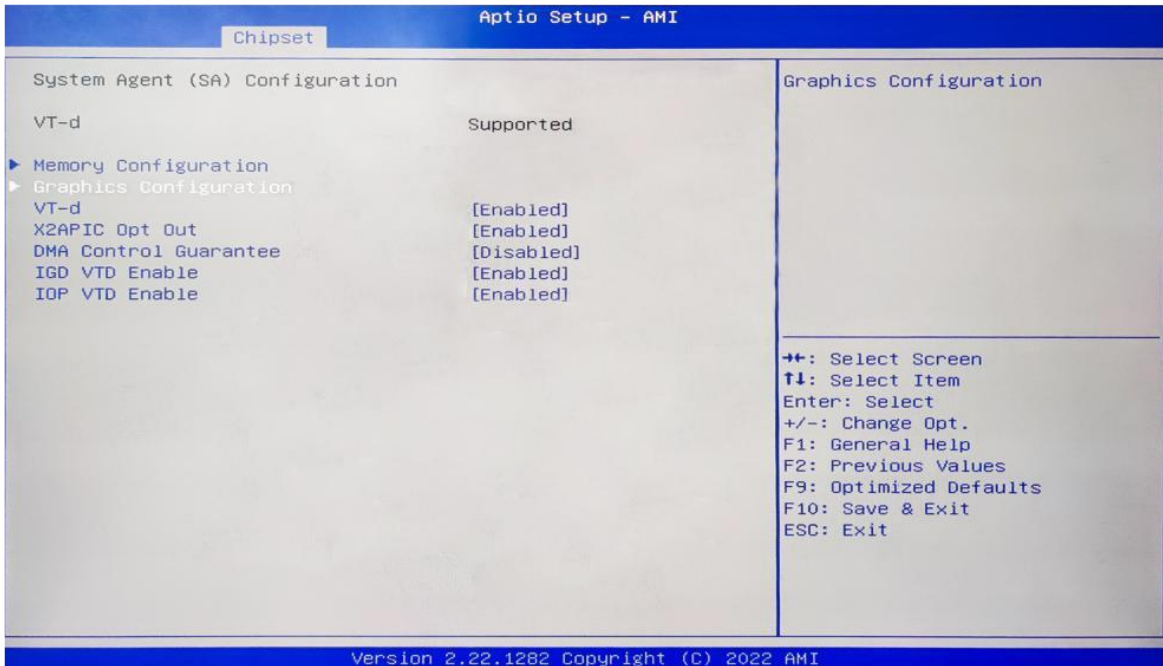

Select "LCD Panel Type" Press Enter, and select the resolution that matches the screen datasheet as shown below:

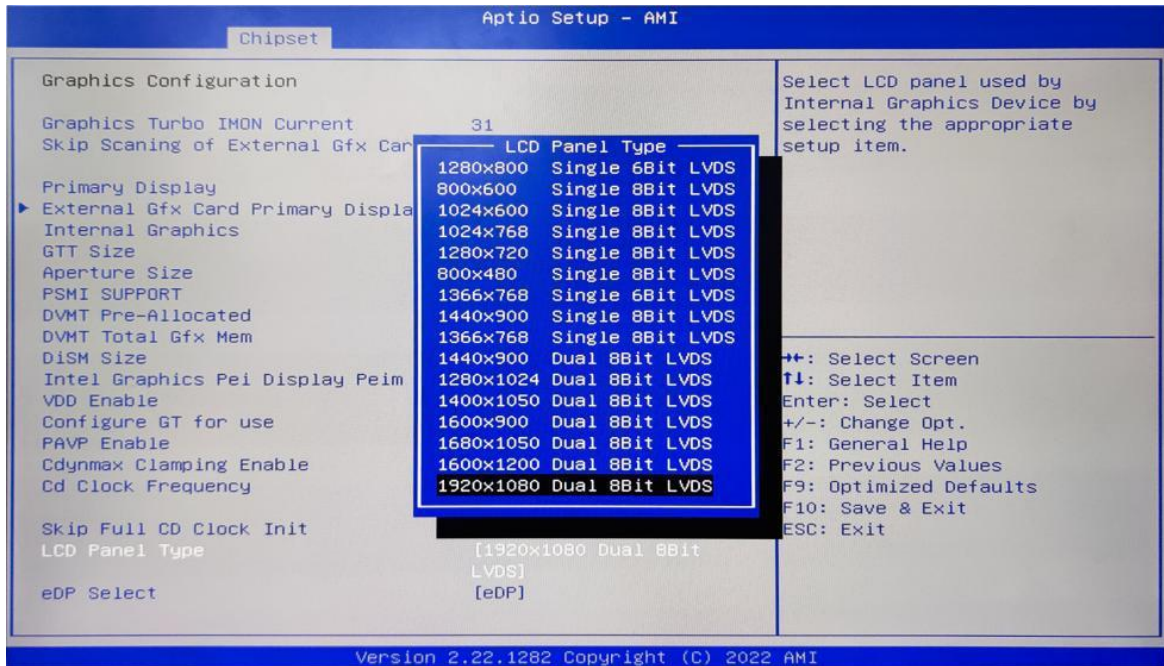

After selecting the matching resolution then press F10 to save and exit, as shown below:

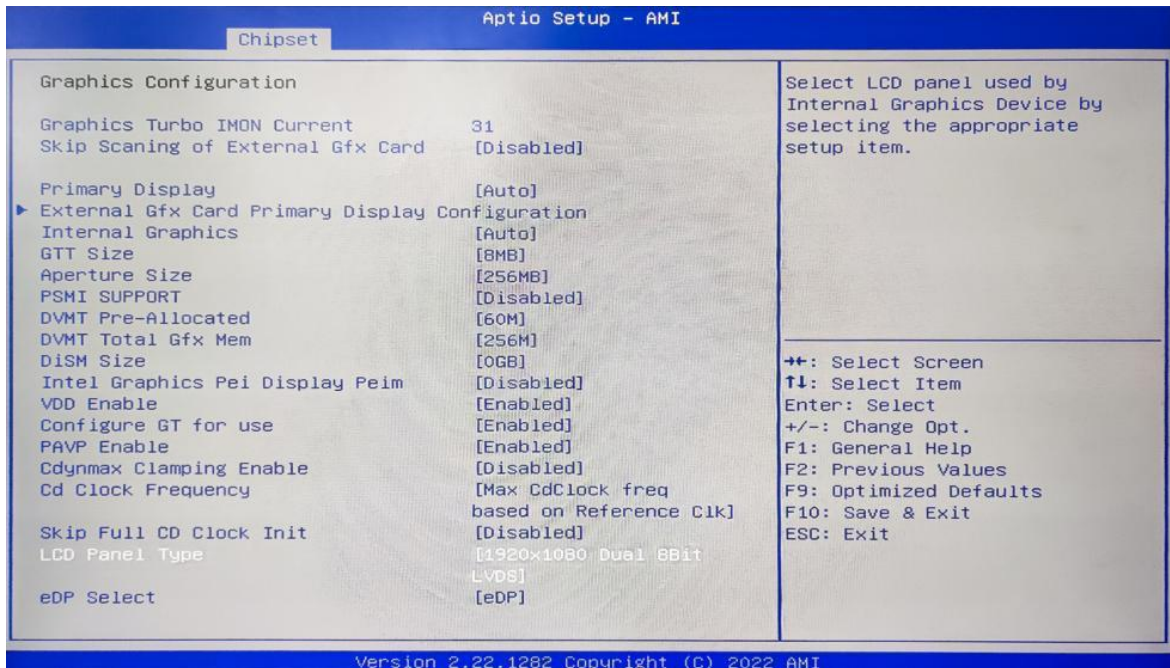

The option "eDP Select" can be set as close and open the LVDS. (Close LVDS: No eDP, open LVDS: eDP).

7 OUTLINE DRAWINGS

INDEX

A	
accurate navigation interface	1-6
Adjust Brightness	4-23
Advanced configuration	1-6, 5-26
AIS	3-16
<i>Any chartplotter</i>	
NMEA2000 Connection	1-3
B	
BASIC OPERATION	4-20
bathymetric recordings	1-4
Baud rates	5-26
BIOS SETUP	7-29
ACPI Settings	7-33
Advanced settings	7-30
CPU-Power Management Control	7-31
Entering the BIOS	7-29
GT-Power Management Control	7-32
Hardware Monitor	7-35
Main setup	7-29
Power and performance	7-30
Super IO Configuration	7-34
Thermal Configuration	7-32
blackbox	1-5
Boot	7-41
Bracket mount	3-8
BRIGHTNESS	6-27
C	
C states	7-31
Chipset	7-39
COG & SOG	3-16
Configuration with chartplotter	
Any chartplotter	1-3
Controls	4-20
CPU Thermal Configuration	7-33
D	
Default configuration	5-26
DISPLAY	6-27
E	
EGNOS	5-24
EMBEDDED GPS	5-24
Enhanced C states	7-31
EQUIPEMENT LIST	2-7
Ethernet connection	1-4
F	
fishing spots	1-4
Flush mount	3-10
flush mounting assembly	3-11
forced shutdown	4-20
G	
GGA	5-25
GLL	5-25
GPS	
Altitude	5-25
channel	5-24
Cold start	5-24
GLONASS	5-24
GSA	5-25
GSV	5-25
GT frequency	7-32
H	
Heading	3-16
I	
identify new spots	1-5
IMPORTANT NOTICES	III
Input PGN	3-15
INSTALLATION	3-8
integrated GPS	5-24
Intel® UHD	6-27
K	
knobs	3-9
L	
LVDS Adjustment	7-43
M	
m8030-kt	5-24
maintain the touch	4-20
Mounting	3-8
mounting gasket	3-11
mounting location	3-8
Multi cable	3-12
Multiple display units	1-5
multiple screens	1-5
N	
Network Stack	7-38
Nmea0183 sentences	5-25
NMEA2000 connection	

connectivity to any sounder	1-3	Touch control.....	4-21
own detailed bathymetric	1-3	Transmission frequency	5-26
NMEA2000 Connector	3-14	U	
NMEA2000 network connection.....	3-14	Ublox	5-24
NMEA2000 PGN.....	3-15	U-center	5-26
NMEA2000 pin definition	3-15	USB Configuration	7-37
NVME Configuration	7-39	V	
O		VTG	5-25
Optional supply.....	2-7	W	
Output PGN	3-17	WAAS	5-24
P		Wake Settings.....	7-37
PC Health Status	7-35	Watch Dog.....	7-36
Power button	4-20	Water Depth	3-16
Power connection	3-13	<i>WiFi Connection</i>	1-4
R		WIRELESS NETWORK.....	6-27
Rapid Update	3-16	Wiring.....	3-12
rear	3-12	X	
requires 12 VDC.....	3-15	XTE	3-16
RMC	5-25		
S			
SAFETY INSTRUCTIONS	IV		
Save and exit.....	7-42		
SBAS.....	5-24		
Security	7-40		
self-tapping screws	3-9		
shutdown.....	4-20		
Smart Fan Function.....	7-36		
sonar view	1-4		
Speed Shift Technology	7-31		
SpeedStep	7-31		
Standard supply.....	2-7		
State After G3	7-40		
synchronize all received data.....	1-6		
SYSTEM CONFIGURATION	1-3		
Configuration with chartplotter	1-3		
System Time	3-16		
T			
TABLE OF CONTENTS	1-1		
TECHNICAL SPECIFICATIONS	6-27		
Aluminium	6-28		
ASPECT RATIO.....	6-27		
DISPLAY TYPE.....	6-27		
ETHERNET NETWORK	6-28		
HARD DRIVE	6-27		
Intel	6-27		
OPERATION SYSTEM.....	6-27		
POWER INPUT	6-28		
RESOLUTION.....	6-27		
TOUCHSCREEN	6-27		

Deeprey Research Ltd®
London, United Kingdom
contact@deeprey.com
www.deeprey.com

DEEPREY®